

SPECIFICATIONS	Model	KTZ32.2							
		KTZ-series 2.2kW, 3-phase							
<p>Type of Pump Submersible high head drainage pump for construction and foundation works, floodwater drainage, etc.</p> <p>Type of Fluid Stormwater, groundwater, wash water, and sand-carrying water</p> <p>Temperature: 0 to 40°C (High temperature model available on special request)</p> <p>Discharge Bore & Connection 80mm, Hose Coupling</p> <p>Motor Output 2.2kW</p> <p>Power Supply Three-phase</p> <p>Starting Method Direct on Line</p> <p>Motor Continuous-duty rated, dry-type induction motor</p> <p>Insulation Class: F Degree of Protection: IP68</p> <p>No. of Poles & Speed (Synchronous Speed) 2-pole, 3000/3600min⁻¹ (50/60Hz)</p> <p>Power Supply Voltages & Rated Currents</p> <table border="0"> <tr> <td>50Hz</td> <td>60Hz</td> </tr> <tr> <td>380V – 5.1A</td> <td>220V – 9.0A</td> </tr> <tr> <td>400V – 5.0A</td> <td>380V – 5.1A</td> </tr> <tr> <td>415V – 5.0A</td> <td>440V – 4.6A</td> </tr> </table> <p>Power Cable Sheath: PVC Standard Length: 8m 200 to 600V supply: 1 x 4 x 1.25mm², O.D. 11.1mm</p> <p>Dry Weight (excluding cable) 34kg</p>	50Hz	60Hz	380V – 5.1A	220V – 9.0A	400V – 5.0A	380V – 5.1A	415V – 5.0A	440V – 4.6A	<p>Impeller Semi-open Impeller made of high-chromium cast iron</p> <p>Solids Passage 50Hz – φ8.5mm 60Hz – φ8.5mm</p> <p>Cable Entry with Anti-Wicking Block Watertight cable entry with strain-relief device. The anti-wicking block prevents water incursion due to capillary action should the power cable be damaged or the end submerged.</p> <p>Bearing Permanently lubricated, deep-groove, double-shielded C3 ball bearings</p> <p>Shaft 420 stainless steel</p> <p>Shaft Seal (Mechanical Seal) Furnished with a double-face mechanical seal located in oil chamber. Both upper and lower seal faces always run in a clean environment.</p> <p>Upper Seal Face: SiC + SiC Lower Seal Face: SiC + SiC</p> <p>Oil Seal (Lip Seal) Used as a “Dust Seal”; it protects the mechanical seal from abrasive particles.</p> <p>OIL LIFTER (Patented) Equipped in oil chamber. It forcibly supplies lubricating oil to the mechanical seal and continues to supply the oil to the upper seal faces even if lubricant falls below the rated volume.</p> <p>Type of Lubricating Oil & Volume Turbine Oil (ISO VG32), 740ml</p> <p>Motor Protection Device A circle thermal protector built in the motor housing. Directly cuts the motor circuit if excessive heat builds up or an overcurrent condition occurs in the motor.</p>
50Hz	60Hz								
380V – 5.1A	220V – 9.0A								
400V – 5.0A	380V – 5.1A								
415V – 5.0A	440V – 4.6A								

NO. A-21087-1

PUMP PERFORMANCE CURVES

TYPE SUBMERSIBLE GENERAL DEWATERING PUMP	MODEL KTZ32.2 -51	FREQUENCY 50 Hz
---	----------------------	--------------------

CUSTOMER'S NAME _____

EQUIPMENT TITLE _____ NO. _____

	STANDARD SPECIFICATIONS	REQUIRED SPECIFICATIONS
DISCHARGE BORE	80 mm	mm
TOTAL HEAD	MAX. 20.4 m	m
CAPACITY	MAX. 0.8 m ³ /min	m ³ /min
MOTOR OUTPUT	2.2 kW	kW
PHASE x VOLTAGE	3 ϕ x V	ϕ x V
CURRENT	A	A
POLES / REVOLUTION	2 P / S. S. 3000 min ⁻¹	P / min ⁻¹
STARTING METHOD	DIRECT ON LINE	
INSULATION CLASS	F	

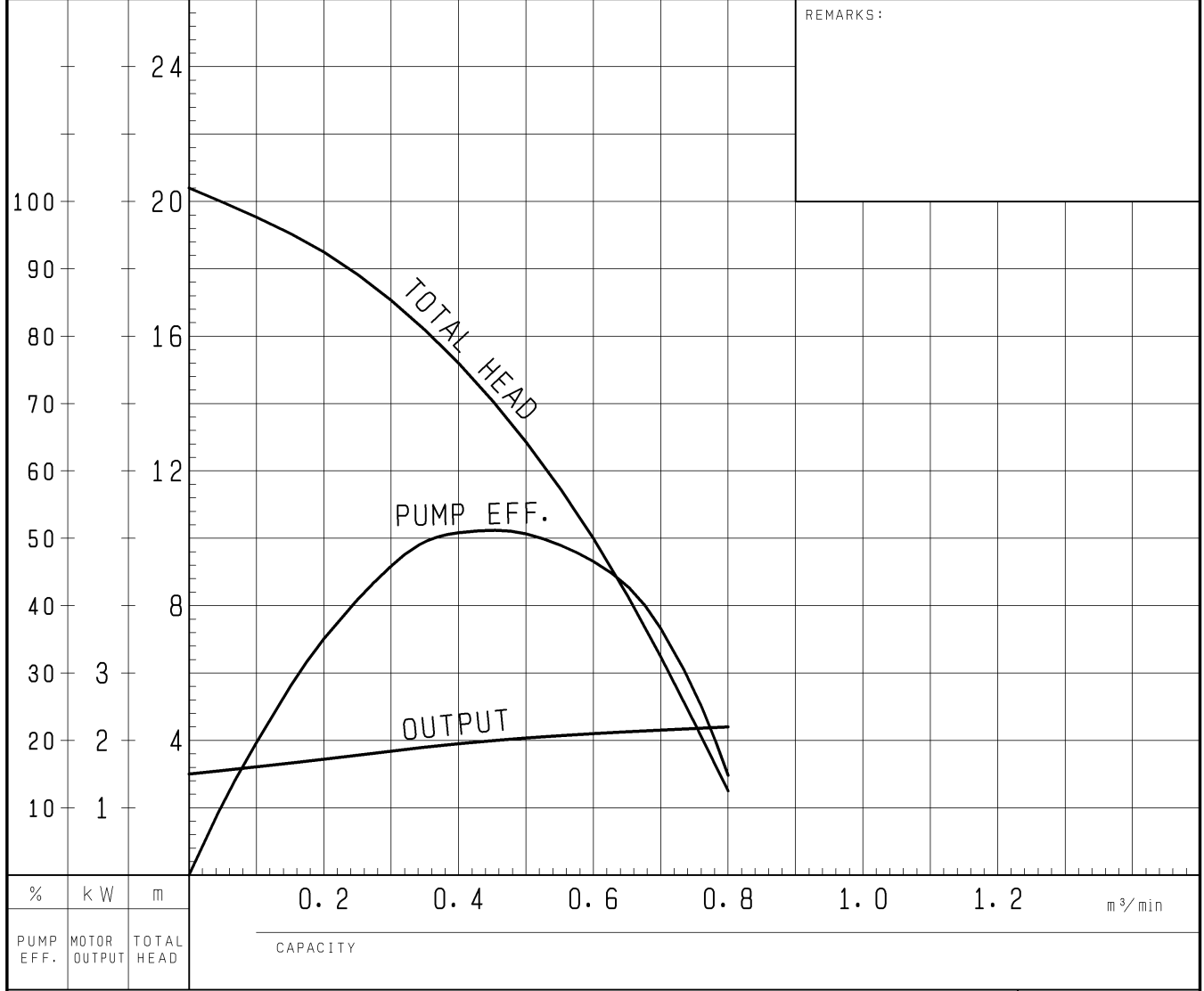

TSURUMI MFG. CO., LTD.

DIMENSION DRAWING		No.	No.	A-21103-1
TYPE	SUBMERSIBLE GENERAL DEWATERING PUMP	MODEL	KTZ21.5 -51/61, KTZ22.2 -51/61 KTZ31.5 -51/61, KTZ32.2 -51/61	

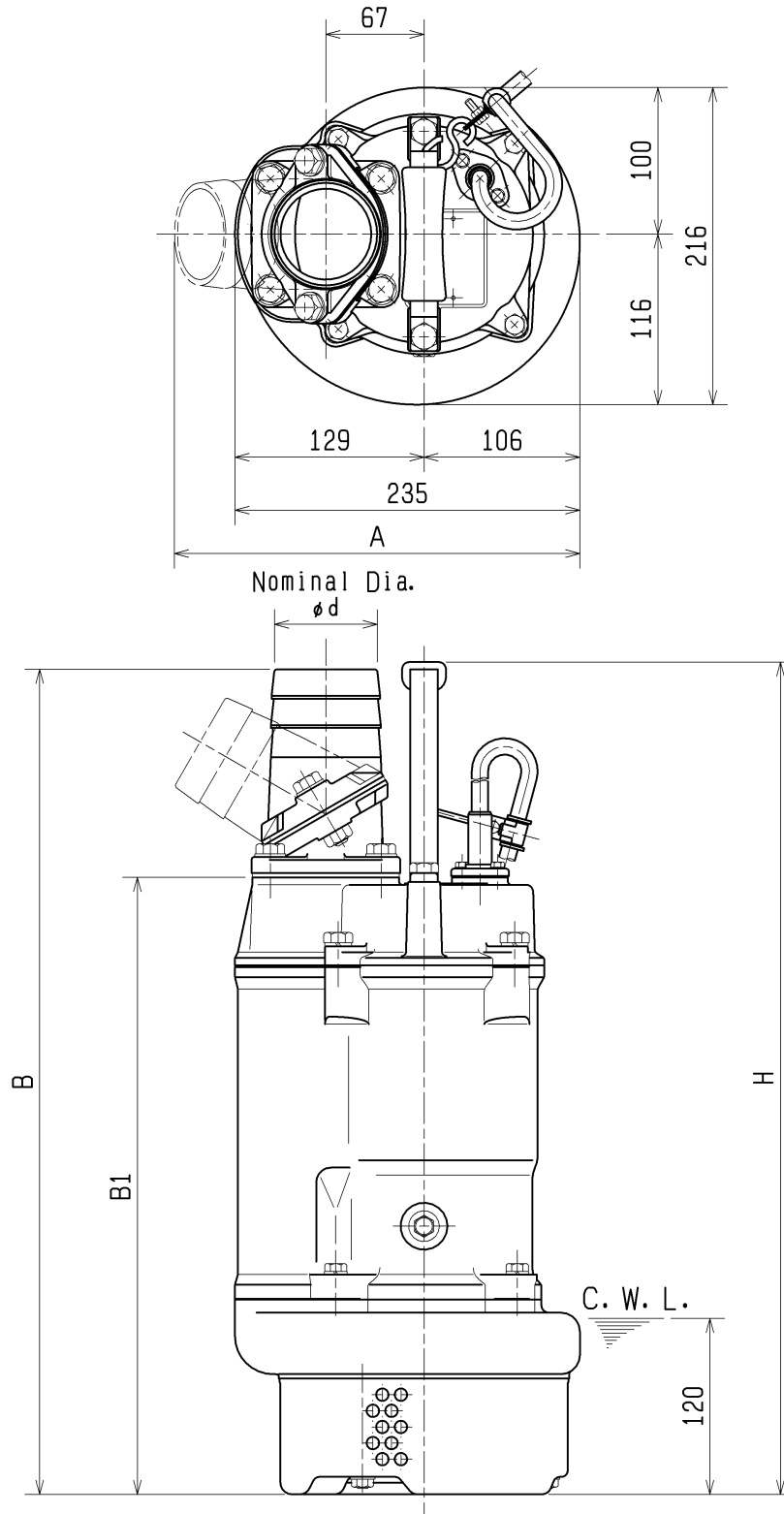

C. W. L. : Continuous running Water Level
*excluding cable

MODEL	d	A	B	B1	H	Approximate Weight (※)
KTZ21.5-51/61	50	270	543	401	548	34kg
KTZ31.5-51/61	80	276	543	401	548	33kg
KTZ22.2-51/61	50	270	563	421	568	35kg
KTZ32.2-51/61	80	276	563	421	568	34kg

SECTIONAL DRAWING		No.	No. A-21107-1
TYPE	SUBMERSIBLE GENERAL DEWATERING PUMP	MODEL	KTZ21.5 -51/61, KTZ22.2 -51/61 KTZ31.5 -51/61, KTZ32.2 -51/61

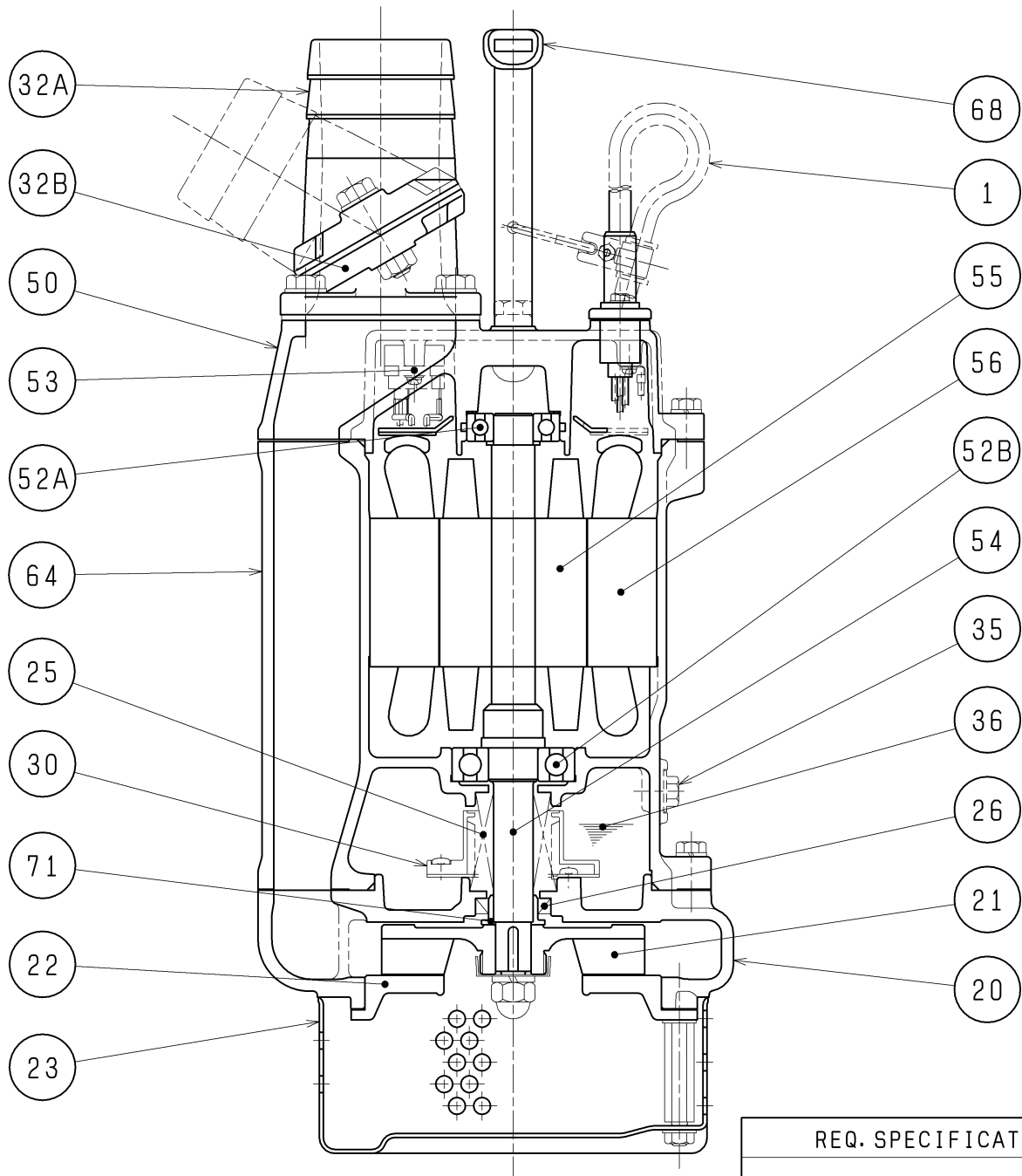

REQ. SPECIFICATION

※ the wetted part

No.	DESCRIPTION	QTY	MATERIAL / NOTE	No.	DESCRIPTION	QTY	MATERIAL / NOTE
1	Cable	1	PVC Sheath	50	Motor Bracket	1	Gray Iron Casting
20	Pump Casing	1	Gray Iron Casting	52A	Upper Bearing	1	6204ZCC3
21	Impeller	1	Chromium Iron Casting	52B	Lower Bearing	1	6305ZCC3
22	Suction Cover	1	Ductile Iron Casting	53	Motor Protector	1	
23	Strainer Stand	1	Steel Sheet	54	Shaft	1	Stainless Steel 420J2(※)
25	Mechanical Seal	1	H-20T	55	Rotor	1	
26	Oil Seal	1	TC25388	56	Stator Complete	1	
30	Oil Lifter	1	Plastic	64	Motor Frame	1	Gray Iron Casting
32A	Hose Coupling	1	Aluminium Die Casting	68	Handle	1	Steel Sheet & Nitrile Butadiene Rubber
32B	Hose Coupling Attachment	1	Aluminium Die Casting	71	Shaft Sleeve	1	Stainless Steel 304
35	Oil Plug	1	Stainless Steel 304				
36	Lubricant		Turbine Oil (ISO VG32)				