

SPECIFICATIONS	Model	LH637	LH-series						
			37kW, 3-phase						
<p>Type of Pump Submersible high head drainage pump for construction and foundation works, floodwater drainage, etc.</p> <p>Type of Fluid Stormwater, groundwater, wash water, and sand-carrying water</p> <p>Temperature: 0 to 40°C</p> <p>Discharge Bore & Connection 150mm, JIS 10kg/cm² Screwed Flange</p> <p>Motor Output 37kW</p> <p>Power Supply Three-phase</p> <p>Starting Method Star-Delta</p> <p>Motor Continuous-duty rated, dry-type induction motor</p> <p>Insulation Class: F Degree of Protection: IP68</p> <p>No. of Poles & Speed (Synchronous Speed) 2-pole, 3000/3600min⁻¹ (50/60Hz)</p> <p>Power Supply Voltages & Rated Currents</p> <table border="0"> <tr> <td>50Hz</td> <td>60Hz</td> </tr> <tr> <td>380V – 70A</td> <td>220V – 120A</td> </tr> <tr> <td>400V – 67A</td> <td>380V – 69A</td> </tr> <tr> <td>415V – 65A</td> <td>440V – 60A</td> </tr> </table> <p>Power Cable Sheath: Chloroprene rubber Standard Length: 10m 380 to 600V supply: 1 x $\begin{pmatrix} 6 \times 22\text{mm}^2 \\ 1 \times 14\text{mm}^2 \\ 2 \times 2\text{mm}^2 \end{pmatrix}$ O.D. 38.8mm 200 to 240V supply: 1 x $\begin{pmatrix} 6 \times 30\text{mm}^2 \\ 1 \times 22\text{mm}^2 \\ 2 \times 2\text{mm}^2 \end{pmatrix}$ O.D. 41.1mm</p> <p>Dry Weight (excluding cable) 495kg</p>	50Hz	60Hz	380V – 70A	220V – 120A	400V – 67A	380V – 69A	415V – 65A	440V – 60A	<p>Impeller Closed Impeller made of high-chromium cast iron</p> <p>Solids Passage 50Hz – ϕ6mm 60Hz – ϕ6mm</p> <p>Mouth Ring Made of high-chromium cast iron, excellent in abrasion-resistance</p> <p>Cable Entry with Anti-Wicking Block Watertight cable entry with strain-relief device. The anti-wicking block prevents water incursion due to capillary action should the power cable be damaged or the end submerged.</p> <p>Bearing Permanently lubricated, deep-groove, double-shielded C3 ball bearings</p> <p>Shaft 420 stainless steel</p> <p>Shaft Seal (Mechanical Seal) Furnished with a double-face mechanical seal located in oil chamber. Both upper and lower seal faces always run in a clean environment.</p> <p>Upper Seal Face: SiC + Carbon Lower Seal Face: SiC + SiC</p> <p>Pressure Relief Port Protects the mechanical seal from over rated limits, and also protects the seal faces from abrasive particles by drawing particles away.</p> <p>OIL LIFTER (Patented) Equipped in oil chamber. It forcibly supplies lubricating oil to the mechanical seal and continues to supply the oil to the upper seal faces even if lubricant falls below the rated volume.</p> <p>Type of Lubricating Oil & Volume Turbine Oil (ISO VG32), 4800ml</p> <p>Motor Protection Device A miniature thermal protector is embedded in each winding of the motor. Should excessive heat builds up, the bimetal strip opens to cause the control panel to shut the power supply.</p> <p>Galvanic Anode Protects the pump from electric corrosion, made of aluminium alloy</p>
50Hz	60Hz								
380V – 70A	220V – 120A								
400V – 67A	380V – 69A								
415V – 65A	440V – 60A								

NO. A-22213-1

PUMP PERFORMANCE CURVES

TYPE Submersible High-Head Dewatering Pump	MODEL LH637 -50	FREQUENCY 50 Hz
---	-----------------	-----------------

CUSTOMER'S NAME _____

EQUIPMENT TITLE _____ NO. _____

	STANDARD SPECIFICATIONS	REQUIRED SPECIFICATIONS
DISCHARGE BORE	150 mm	mm
TOTAL HEAD	80 / 60 m	m
CAPACITY	1 / 2 m ³ /min	m ³ /min
MOTOR OUTPUT	37 kW	kW
PHASE x VOLTAGE	3 ϕ x V	ϕ x V
CURRENT	A	A
POLES / REVOLUTION	2 P / S. S. 3000 min ⁻¹	P / min ⁻¹
STARTING METHOD	STAR DELTA	
INSULATION CLASS	F	

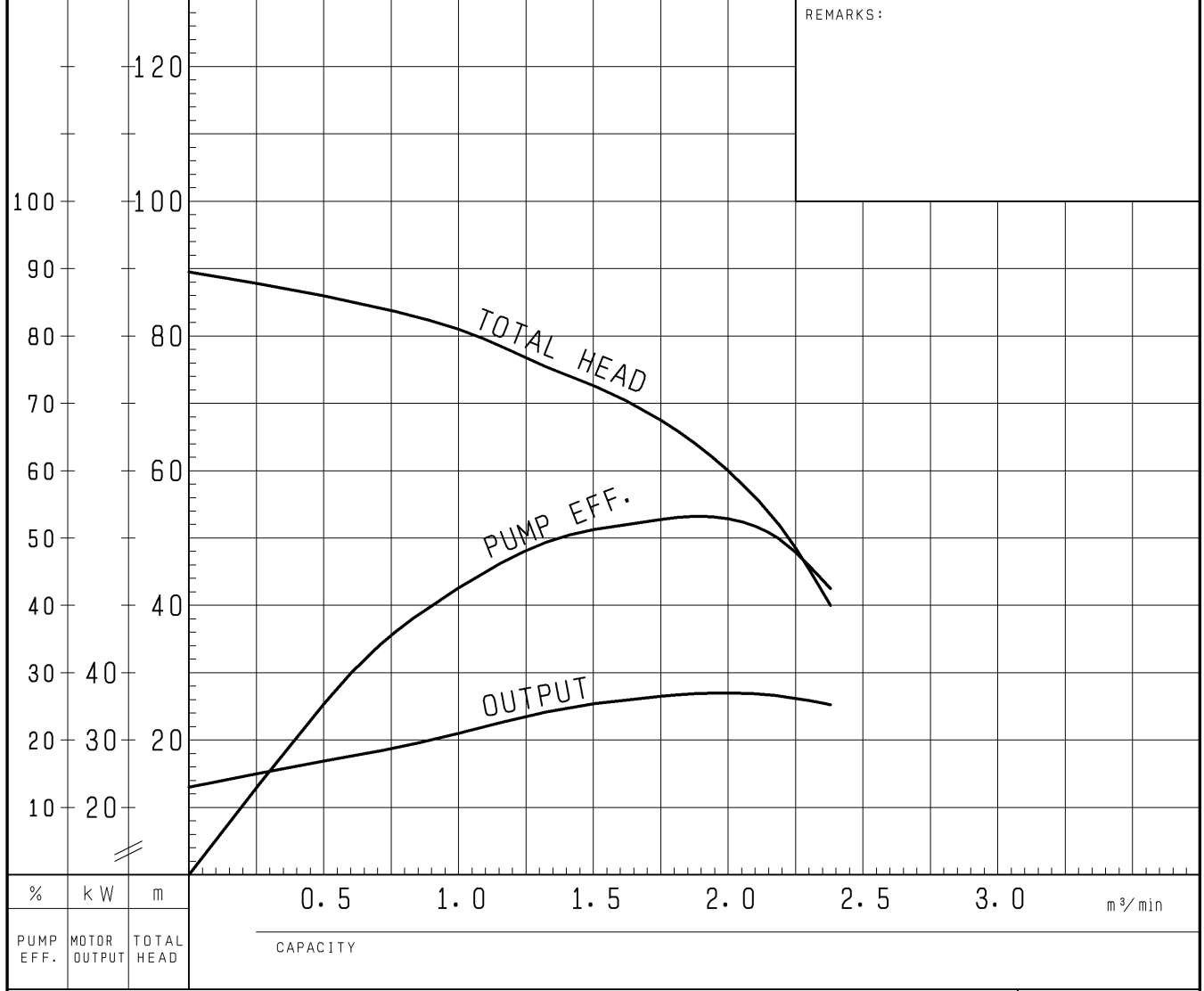

TSURUMI MFG. CO., LTD.

DIMENSION DRAWING		No.	No.	A-22229-1
TYPE Submersible High-Head Dewatering Pump		MODEL	LH637 -50/60, LH645 -50/60 LH837 -50/60, LH845 -50/60	

MODEL	Approximate Weight (※)
LH637-50/60	495kg
LH645-50/60	510kg
LH837-50/60	495kg
LH845-50/60	510kg

※excluding cable

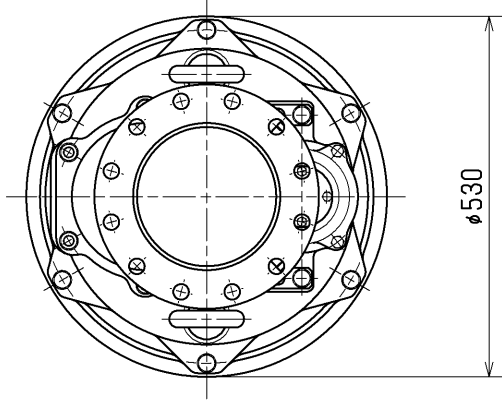

JIS10K Flange
Nominal Dia.
φ200 (φ150)

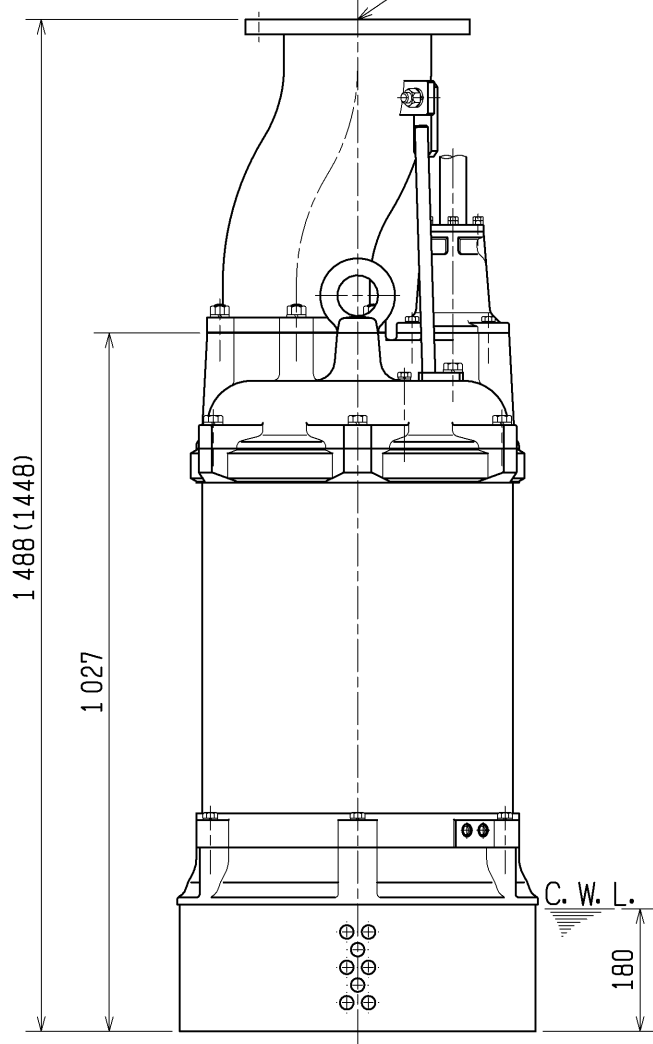

The Figure in () shows the dimensions of LH637 and LH645.

C. W. L. :Continuous running Water Level

SECTIONAL DRAWING		No.	No.	A-22231-2
TYPE Submersible High-Head Dewatering Pump		MODEL LH637 -50/60, LH645 -50/60 LH837 -50/60, LH845 -50/60		

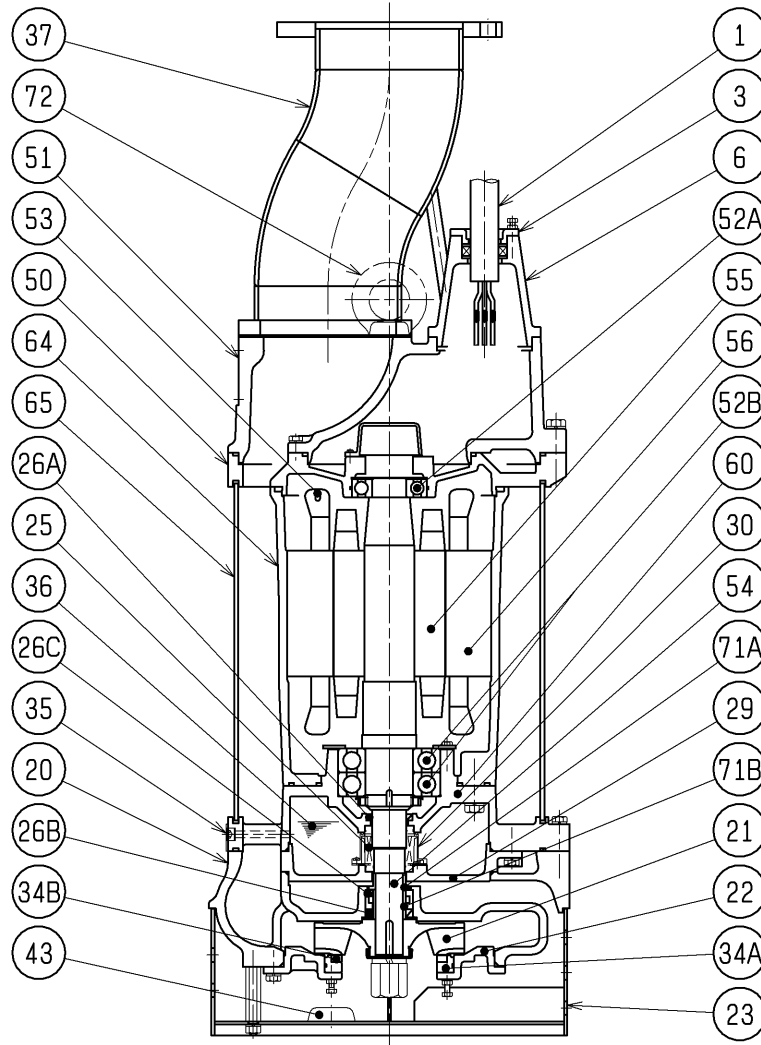

REQ. SPECIFICATION

※ the wetted part

No.	DESCRIPTION	QTY	MATERIAL / NOTE	No.	DESCRIPTION	QTY	MATERIAL / NOTE
1	Cable	1	Chloroprene Sheath	43	Cathodic Protection Plate	3	Aluminium Alloy
3	Gland	1	Gray Iron Casting	50	Motor Bracket	1	Gray Iron Casting
6	Stuffing Box	1	Gray Iron Casting	51	Head Cover	1	Gray Iron Casting
20	Pump Casing	1	Gray Iron Casting	52A	Upper Bearing	1	6310ZZC3
21	Impeller	1	Chromium Iron Casting	52B	Lower Bearing	1	6314ZZD2C3
22	Suction Cover	1	Gray Iron Casting	53	Motor Protector	3	
23	Strainer Stand	1	Structure Steel	54	Shaft	1	Stainless Steel 420J2(※)
25	Mechanical Seal	1	HT-4550N	55	Rotor	1	
26A	Oil Seal	1	SC50689	56	Stator	1	
26B	Oil Seal	1	TCN487012	60	Bearing Housing	1	Gray Iron Casting
26C	Labyrinth Ring	1	Stainless Steel 304	64	Motor Frame	1	Gray Iron Casting
29	Oil Casing	1	Gray Iron Casting	65	Outer Cover	1	Structure Steel
30	Oil Lifter	1	Plastic	71A	Upper Shaft Sleeve	1	Stainless Steel 403
34A	Suction Mouth	1	Gray Iron Casting	71B	Lower Shaft Sleeve	1	Stainless Steel 403
34B	Mouth Ring	1	Chromium Iron Casting	72	Eyebolt	2	Structure Steel
35	Oil Plug	2	Stainless Steel 304				
36	Lubricant		Turbine Oil (ISO VG32)				
37	Discharge Pipe	1	Structure Steel & Carbon Steel Pipe				