



# Submersible Wastewater Pumps ***Vortex Impeller***

## PN



Being made of stainless steel and special resin, the PN-series is not only lightweight but corrosion-resistant as well. The semi-vortex pump design with moderate impeller passage provides efficient performance for versatile applications.

### ① Cable Entry



Every cabtyre cable has an anti-wicking block at the cable entry section on the pump. This mechanism is such that a part of each conductor is stripped back and the part is sealed by molded rubber or epoxy potting which has flowed in between each strand of the conductor. This unique feature prevents wicking along the strand of the conductor itself.

### ④ Back Pull-Out Design

Unfastening the bolts between the oil casing and the upper pump casing allows the body to be separated into the pump section and the motor section with the impeller left in position. This facilitates inspections of the main portions. The pump section can be disassembled/reassembled using a large Phillips screwdriver.



### ② Motor

The motor is a dry-type, squirrel-cage induction motor, housed in a watertight casing, and conforms to insulation class E. All standard pumps can be used in ambient temperatures up to 40°C.

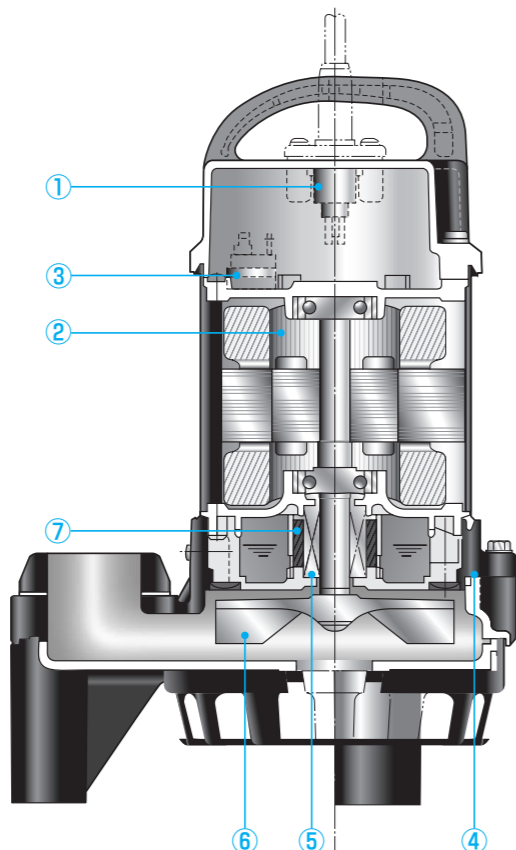

### ⑥ Impeller

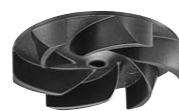

Equipped with a vortex impeller with high-gap structure which has a good passage characteristic and high pumping performance, these pumps are ideal to transfer or discharge wastewater containing impurities.

### ③ Motor Protector

A built-in thermal motor protection device reacts to the heat caused by overcurrent or run-dry conditions. It not only cuts off the motor circuit automatically but also resets by itself. When the motor cools down to a safe operating temperature, the motor restarts.

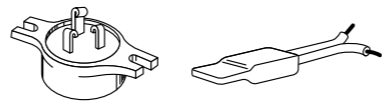

### ⑤ Mechanical Seal

The mechanical seal with two seal faces containing silicon carbide (SiC) is equipped with the oil chamber. The advantages of the seal are two-fold, it eliminates spring failure caused by corrosion, abrasion or fouling which prevents the seal faces from closing properly, and prevents loss of cooling to the bottom seal faces during run-dry conditions which causes the bottom seal to fail.

### ⑦ Oil Lifter (Pat. Pending)

The Oil Lifter was developed as a lubricating device for the mechanical seal. Utilizing the centrifugal force of the shaft seal, the Oil Lifter forcibly supplies lubricating oil to the mechanical seal and continues to supply the oil to the upper seal faces even if lubricant falls below the rated volume. This amazingly simple device is not only reliably lubricates and cools down, but also retains the stable shaft seal effect and extends the inspection term.



## Technical Data

PN

### Performance Curves

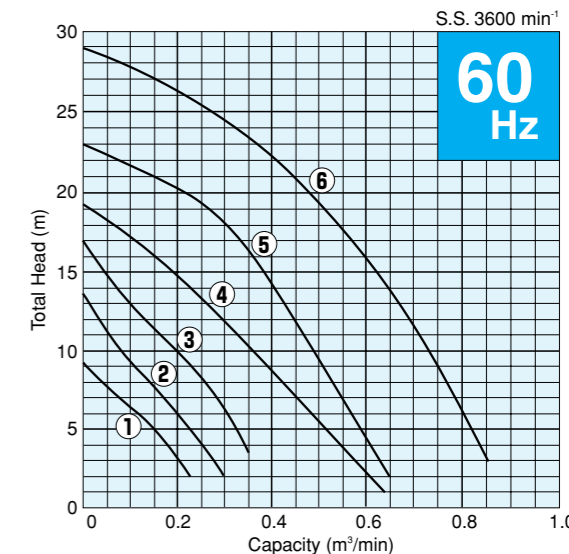
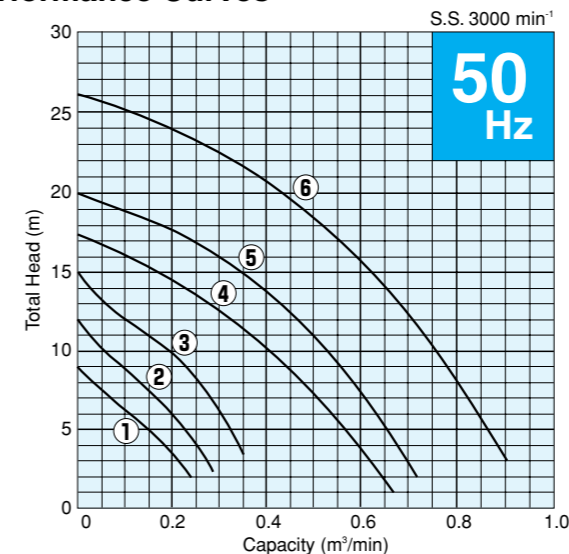

### Standard Specifications 50/60Hz

Curve No.	Discharge Bore mm	Standard Model	Automatic Model	Auto-alternation Model	Motor Output kW	Phase	Starting Method	Impeller Passage mm	Cable Length m	Cable Code	Dimensions L x H mm		Dry Weight <sup>*)</sup> kg	
											Standard	Auto & Auto-alternation	Standard	Auto & Auto-alternation
1	40	40PN2.25S	40PNA2.25S	40PNW2.25S	0.25	Single	Capacitor Run	10	5	a	236 x 360	236 x 374	7.1	7.7
	40	40PN2.25	40PNA2.25	40PNW2.25	0.25	Three	D.O.L.	10	6	A	236 x 349	236 x 363	6.1	6.7
2	50	50PN2.4S	50PNA2.4S	50PNW2.4S	0.4	Single	Capacitor Run	10	5	a	236 x 360	236 x 374	7.1	7.7
	50	50PN2.4	50PNA2.4	50PNW2.4	0.4	Three	D.O.L.	10	6	A	236 x 360	236 x 374	7.0	7.5
3	50	50PN2.75S	50PNA2.75S	—	0.75	Single	Capacitor Run	10	5	a(b <sup>*)</sup> )	236 x 380	236 x 394	9.0	9.5
	50	50PN2.75	50PNA2.75	50PNW2.75	0.75	Three	D.O.L.	10	6	A	236 x 374	236 x 388	8.3	8.8
4	50	50PN21.5	50PNA21.5	50PNW21.5	1.5	Three	D.O.L.	20	6	A	295 x 435	295 x 435	15.9	16.6
5	80	80PN22.2	80PNA22.2	80PNW22.2	2.2	Three	D.O.L.	20	6	A(C <sup>*)</sup> )	311 x 559	311 x 559	22.0	23.0
6	80	80PN23.7	80PNA23.7	80PNW23.7	3.7	Three	D.O.L.	20	6	C(E <sup>*)</sup> )	311 x 594	311 x 594	27.0	28.0

\*1 110~120V \*2 200~240V \*3 All weights excluding cable

### Cabtyre Cable Code Reference

Single-Phase

Code	Pcs/unit	Cores x mm <sup>2</sup>	Dia. mm	Material
a	1	3 x 1.25	10.1	PVC
b	1	3 x 2.0	10.9	

Three-Phase

Code	Pcs/unit	Cores x mm <sup>2</sup>	Dia. mm	Material
A	1	4 x 1.25	11.1	PVC
C	1	4 x 2.0	11.8	
E	1	4 x 3.5	13.9	

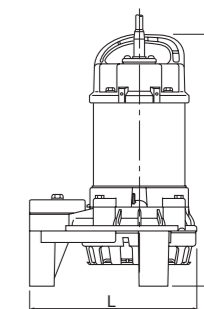

## MODEL NUMBER DESIGNATION

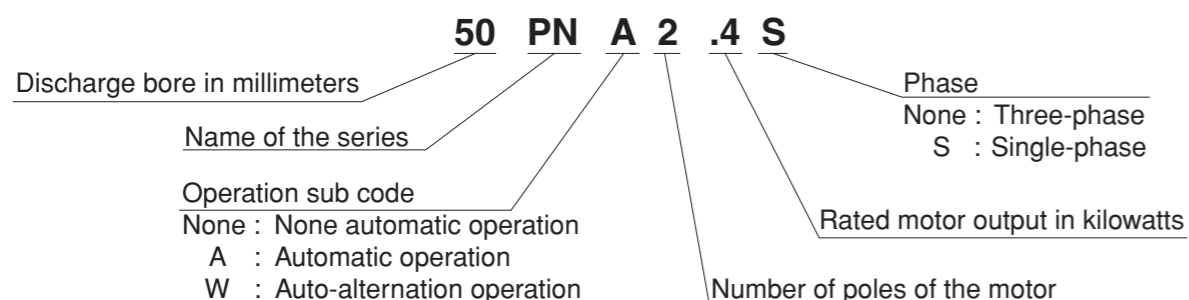

## Optional Accessory

### TOK Guide Rail Fitting System

Tsurumi provides TOK-type guide rail fitting system for all PN-series pumps. The fittings connect a pump to, or separate it from, piping only by lifting the pump up/down. No need to enter in the pump sump for maintenance.



#### Advantages

##### No Water Leak

Rubber bellows attached to the guide hook are inverted to the duckfoot bend when the pump starts operation. The bellows are kept inverted while the pump is stopped. This eliminates leaks even if a lightweight pump is connected with the guide hook.

##### Immune to Rust

The guide hook, guide support and duckfoot bend are made of high-quality resin and secured in position with stainless steel bolts and washers. This prevents corrosion completely.

#### TOK Application Table

TOK Model	Applicable Pump Models
TOK4-P	0.25 to 0.75kW Models
TOK2-65	Model 50PN21.5
TOK2-65T	2.2 to 3.7kW Models

#### Contents of TOK

- Guide Support with Bolts & Nuts
- Guide Hook
- Duckfoot Bend
- Lifting Chain with Shackles (4m for TOK4-P, 5m for TOK2-65 / 65T)



## Automatic Model

Tsurumi automatic models have an integral control circuit and two float switches operated at low voltages.

The automatic models are indicated by the symbol, A, added to the series name in the model code. They are available in all sizes of the series.



## Auto-Alternation Model

Tsurumi also offers auto-alternation model for dual automatic operations using two pumps at a time. Just combine an ordinary automatic model (2 floats) to an auto-alternation model (3 floats). This enables the two pumps to operate alternately without control panel.

The auto-alternation models are identified by the symbol, W, added to the series name in the model code. They are available in the same output ranges as those of the ordinary automatic models.

### How the Auto-alternation Model Works

- Operation is enabled by merely connecting the power supply.

#### Primary Operation

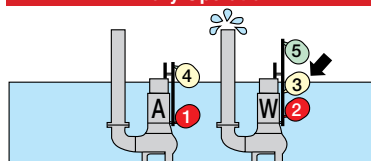

1. Float 3 operates, and pump W starts to discharge water.

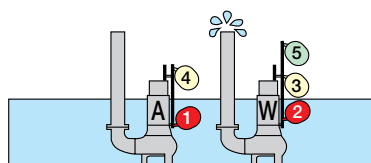

2. Water is discharged (water level falls).

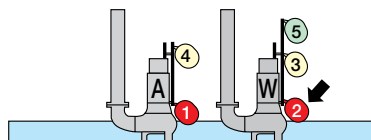

3. Stop float 2 of pump W operates to end water discharge. At this time, alternation start float 3 of pump W rests for one discharge operation.

#### Secondary Operation

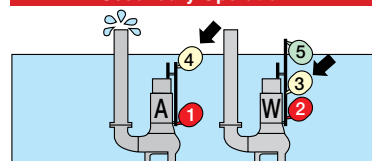

1. Start float 4 of pump A operates to start water discharge. The pump ends primary operation, and stops operating.

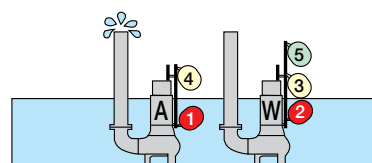

2. Water is discharged (water level falls).

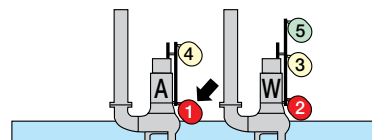

3. Stop float 1 of pump A operates to end water discharge. At the same time, start float 3 of pump W becomes ready for operation.

- ※Primary operation and secondary operation are repeated alternately.
- ※Both primary and secondary operations are performed simultaneously when water has risen to an abnormal level.

We reserve the right to change the specifications and designs for improvement without prior notice.

**TSURUMI**  
MANUFACTURING CO., LTD.

Your Dealer