

SPECIFICATIONS	Model	50TM2.75							
		TM-series 0.75kW, 3-phase							
<p>Type of Pump Submersible semi-vortex pump made of titanium and resin suitable for pumping seawater</p> <p>Type of Fluid Seawater</p> <p>Temperature: 0 to 40°C</p> <p>Discharge Bore 50mm</p> <p>Motor Output 0.75kW</p> <p>Power Supply Three-phase</p> <p>Starting Method Direct on Line</p> <p>Motor Continuous-duty rated, dry-type induction motor</p> <p>Insulation Class: E Degree of Protection: IP68</p> <p>No. of Poles & Speed (Synchronous Speed) 2-pole, 3000/3600min⁻¹ (50/60Hz)</p> <p>Power Supply Voltages & Rated Currents</p> <table border="0"> <tr> <td>50Hz</td> <td>60Hz</td> </tr> <tr> <td>380V – 2.0A</td> <td>220V – 3.2A</td> </tr> <tr> <td>400V – 1.9A</td> <td>380V – 1.8A</td> </tr> <tr> <td>415V – 1.9A</td> <td>440V – 1.6A</td> </tr> </table> <p>Power Cable Sheath: PVC Standard Length: 6m 200 to 600V supply: 1 × 4 × 1.25mm², O.D. 11.1mm</p> <p>Dry Weight (excluding cable) Standard Model: 7.8kg Automatic Model: 8.4kg</p>	50Hz	60Hz	380V – 2.0A	220V – 3.2A	400V – 1.9A	380V – 1.8A	415V – 1.9A	440V – 1.6A	<p>Impeller Vortex impeller designed for “high-gap structure”, made of glass-fiber reinforced PPO</p> <p>Solids Passage 50Hz – φ10mm 60Hz – φ10mm</p> <p>Cable Entry with Anti-Wicking Block Watertight cable entry with strain-relief device. The anti-wicking block prevents water incursion due to capillary action should the power cable be damaged or the end submerged.</p> <p>Bearings Permanently lubricated, deep-groove, double-shielded C3 ball bearings</p> <p>Shaft Titanium</p> <p>Shaft Seal (Mechanical Seal) Furnished with a double-face mechanical seal located in oil chamber. Both upper and lower seal faces always run in a clean environment.</p> <p>Upper Seal Faces: Ceramic + Carbon Lower Seal Faces: SiC + Ceramic</p> <p>OIL LIFTER (Patented) Equipped in oil chamber. It forcibly supplies lubricating oil to the mechanical seal and continues to supply the oil to the upper seal faces even if lubricant falls below the rated volume.</p> <p>Type of Lubricating Oil & Volume Liquid Paraffin (ISO VG32), 240ml</p> <p>Motor Protection Device A circle thermal protector built in the motor housing. Directly cuts the motor circuit if excessive heat builds up or an overcurrent condition occurs in the motor.</p>
50Hz	60Hz								
380V – 2.0A	220V – 3.2A								
400V – 1.9A	380V – 1.8A								
415V – 1.9A	440V – 1.6A								

NO. A-10197-1

PUMP PERFORMANCE CURVES

TYPE Sea Water Submersible Titanium Seawater Pump	MODEL 50TM2.75 -52 50TMA2.75 -52	FREQUENCY 50 Hz
---	-------------------------------------	--------------------

CUSTOMER'S NAME _____

EQUIPMENT TITLE _____ NO. _____

	STANDARD SPECIFICATIONS	REQUIRED SPECIFICATIONS
DISCHARGE BORE	50 mm	mm
TOTAL HEAD	11.5 m	m
CAPACITY	0.13 m ³ /min	m ³ /min
MOTOR OUTPUT	0.75 kW	kW
PHASE x VOLTAGE	3 φ × V	φ × V
CURRENT	A	A
POLES / REVOLUTION	2 P / S. S. 3000 min ⁻¹	P / min ⁻¹
STARTING METHOD	DIRECT ON LINE	
INSULATION CLASS	E	

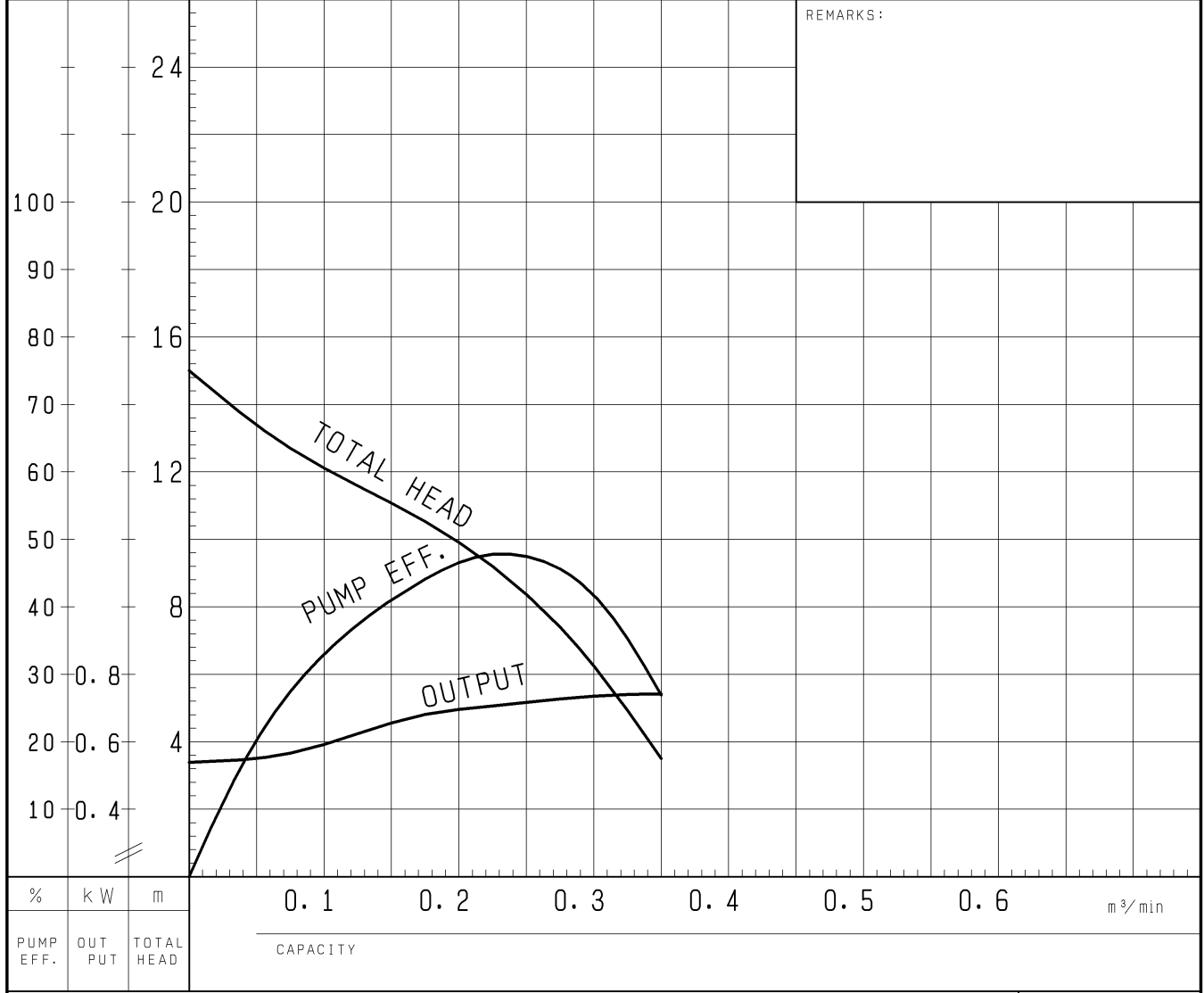

TSURUMI MFG. CO., LTD.

DIMENSION DRAWING		No.	No. A-10210-2
TYPE	Sea Water Submersible Titanium Seawater Pump	MODEL	50TM2.75 -52/62

Approximate Weight (※)
7.8kg

※excluding cable

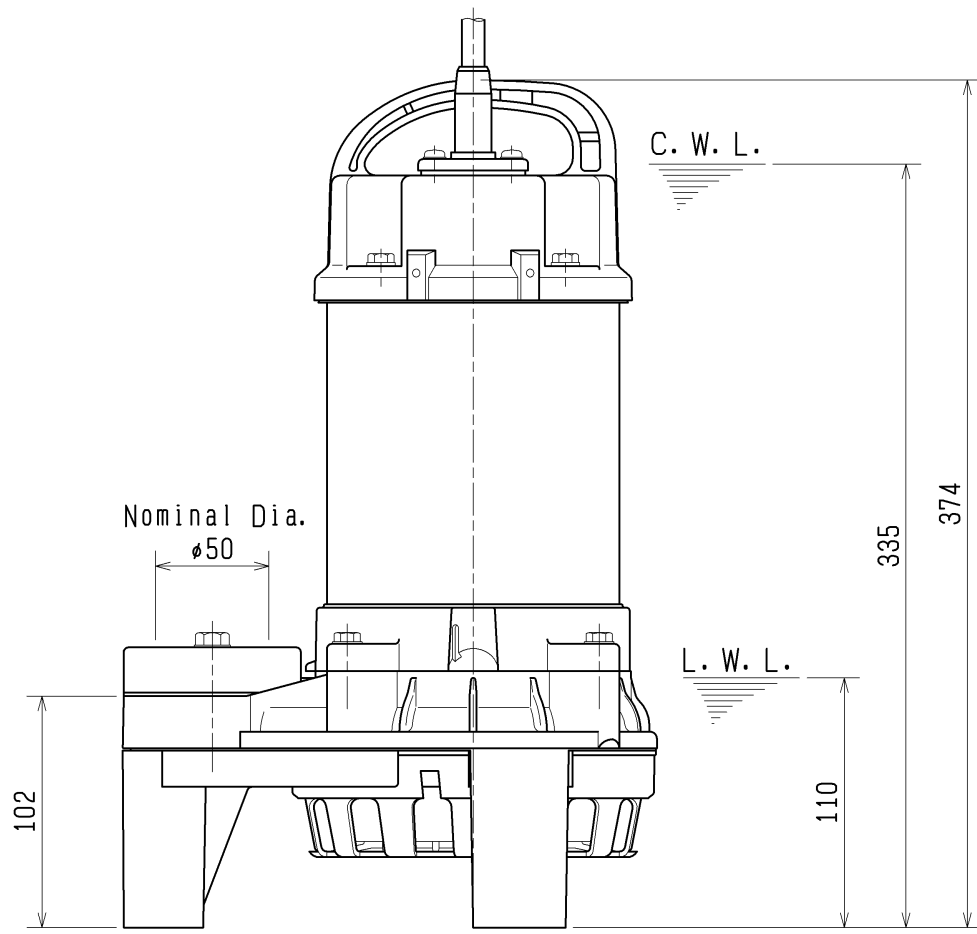
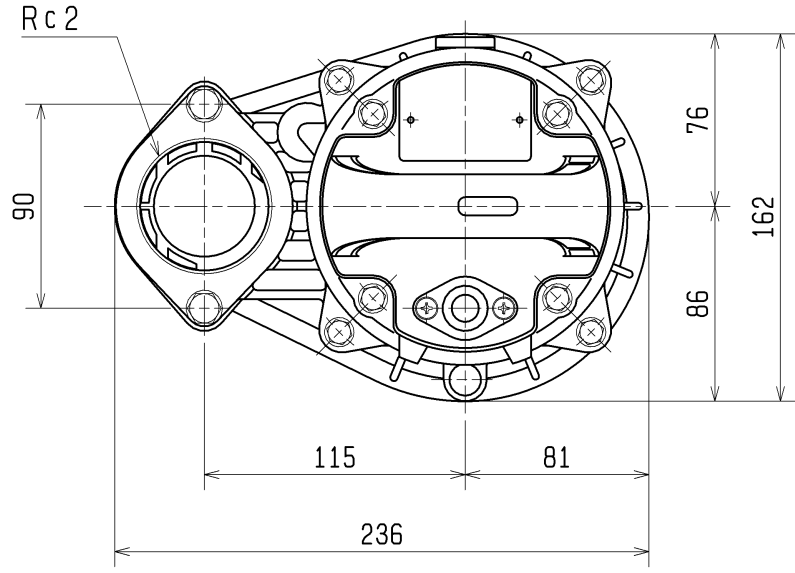

C.W.L. : Continuous running Water Level
L.W.L. : Lowest running Water Level

SECTIONAL DRAWING		No.	No. A-10216-4
TYPE	Sea Water Submersible Titanium Seawater Pump	MODEL	40TM2.25 -52/62, 50TM2.4 -52/62 50TM2.75 -52/62

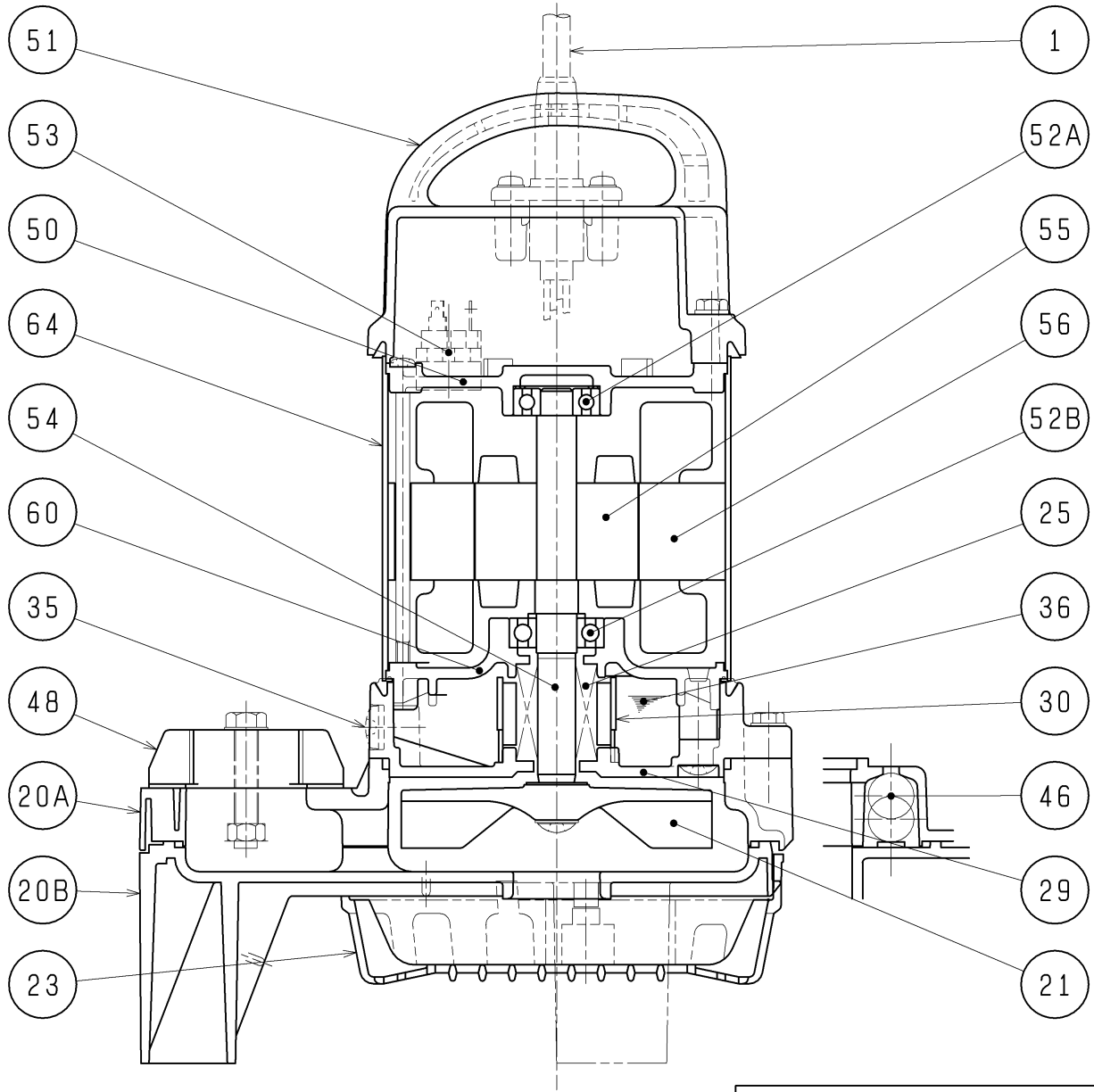

REQ. SPECIFICATION	

* All metal parts (including cable gland, bolts, nuts, washers, etc.) contacting with liquid are made of TITANIUM.

* Upper and lower blocks form a one-piece casing.

No.	DESCRIPTION	Q'TY	MATERIAL / NOTE	No.	DESCRIPTION	Q'TY	MATERIAL / NOTE
1	Cable	1	PVC Sheath	50	Motor Bracket	1	Aluminium Die Casting
20A	Upper Pump Casing	* 1	Plastic W/GF	51	Head Cover	1	Plastic W/GF
20B	Lower Pump Casing		Plastic	52A	Upper Bearing	1	6201ZZC3
21	Impeller	1	Plastic W/GF	52B	Lower Bearing	1	6302ZZC3
23	Strainer	1	Plastic	53	Motor Protector	1	
25	Mechanical Seal	1	W-14HC	54	Shaft	1	Titanium
29	Oil Casing	1	Plastic W/GF	55	Rotor	1	
30	Oil Lifter	1	Plastic	56	Stator	1	
35	Oil Plug	1	Titanium	60	Bearing Housing	1	Aluminium Die Casting
36	Lubricant		Liquid Paraffin (ISO VG32)	64	Motor Frame	1	Titanium
46	Air Release Valve	1	Glass Ball				
48	Screwed Flange	1	Plastic W/GF				