

BER Series

Submersible Ejector

OPERATION MANUAL

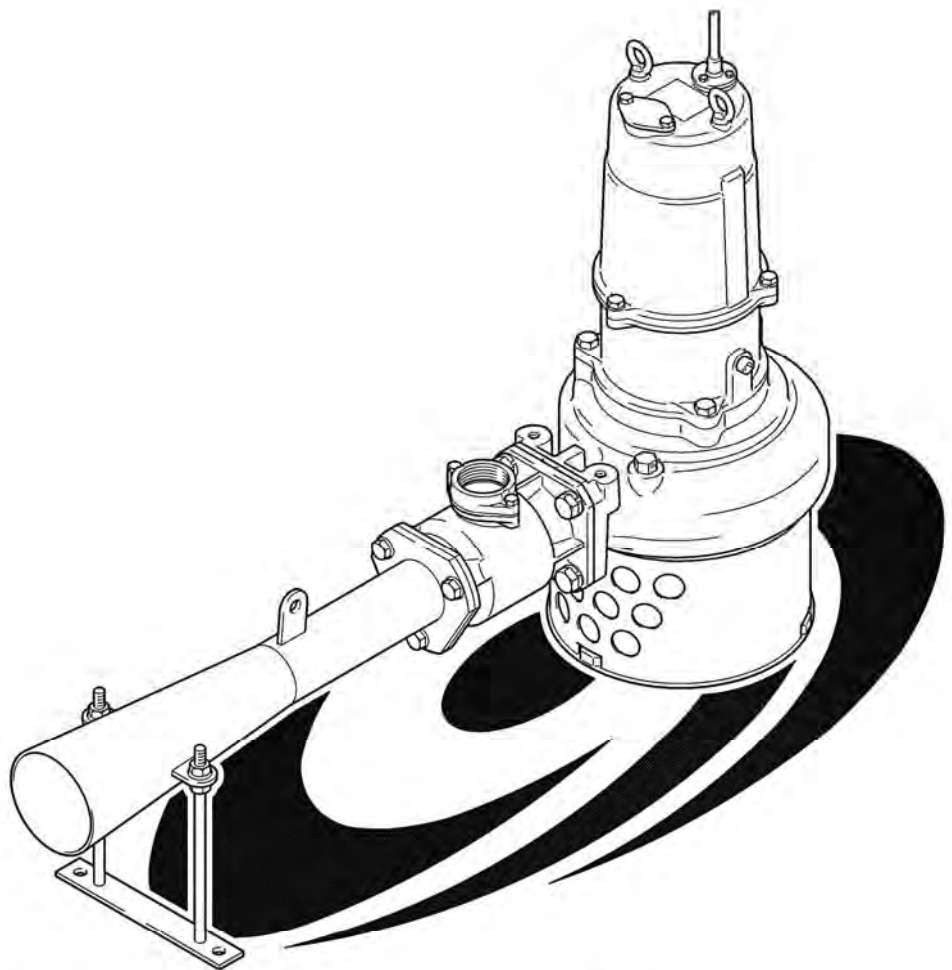

TSURUMI MANUFACTURING CO., LTD.

INTRODUCTION

Thank you for selecting the Tsurumi BER Series submersible ejector.

This operation manual explains the product operations and gives important precautions regarding its safe use. In order to use the product to maximum benefit, be sure to read the instructions thoroughly and follow them carefully.

To avoid accident, do not use the product in any way other than as described in this operation manual. Note that the manufacturer cannot be responsible for accidents arising because the product was not used as prescribed. After reading this operation manual, keep it nearby as a reference in case questions arise during use.

When lending this product to another party, always be sure to include this operation manual as well.

If this operation manual should become lost or damaged, ask your nearest dealer or Tsurumi representative for another copy.

Every effort has been made to ensure the completeness and accuracy of this document. Please contact your nearest dealer or Tsurumi representative if you notice any possible error or omission.

The contents of this document may not be copied in whole or in part without the express permission of Tsurumi Manufacturing Co., Ltd.

CONTENTS

1. BE SURE TO READ FOR YOUR SAFETY	1
2. NAME OF PARTS	4
3. PRIOR TO OPERATION	4
4. INSTALLATION	6
5. ELECTRICAL WIRING	10
6. OPERATION.....	11
7. MAINTENANCE AND INSPECTION.....	13
8. DISASSEMBLY AND REASSEMBLY	15
9. TROUBLESHOOTING	17

1 BE SURE TO READ FOR YOUR SAFETY

Be sure to thoroughly read and understand the SAFETY PRECAUTIONS given in this section before using the equipment in order to operate the equipment correctly.

The precautionary measures described in this section are intended to prevent danger or damage to you or to others. The contents of this manual that could possibly be performed improperly are classified into two categories: **⚠ WARNING**, and **⚠ CAUTION**. The categories indicate the extent of possible damage or the urgency of the precaution. Note however, that what is included under **⚠ CAUTION** may at times lead to a more serious problem. In either case, the categories pertain to safety-related items, and as such, must be observed carefully.

- **⚠ WARNING** : Operating the equipment improperly by failing to observe this precaution may possibly lead to death or injury to humans.
- **⚠ CAUTION** : Operating the equipment improperly by failing to observe this precaution may possibly cause injury to humans and other physical damage.
- **NOTE** : Gives information that does not fall in the WARNING or CAUTION categories.
- **Explanation of Symbols:**



The **⚠** mark indicates a WARNING or CAUTION item. The symbol inside the mark describes the precaution in more detail ("electrical shock", in the case of the example on the left).



The **⊘** mark indicates a prohibited action. The symbol inside the mark, or a notation in the vicinity of the mark describes the precaution in more detail ("disassembly prohibited", in the case of the example on the left).



The **⚡** mark indicates an action that must be taken, or instructs how to perform a task. The symbol inside the mark describes the precaution in more detail ("provide ground work", in the case of the example on the left).

PRECAUTIONS TO THE PRODUCT SPECIFICATIONS

⚠ CAUTION





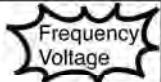







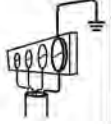



● Do not operate the product under any conditions other than those for which it is specified. **Failure to observe the precaution can lead to electrical leakage, electrical shock, fire, or other problems.**



















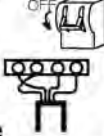



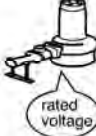



PRECAUTIONS DURING TRANSPORT AND INSTALLATION

⚠ WARNING









	<p>● When transporting the product, pay close attention to its center of gravity and mass. Use an appropriate lifting equipment to lift the unit. Improper lifting may result in the product damage, injury, or death.</p> 		<p>● Install the product properly in accordance with this operation manual. Improper installation may result in electrical leakage, electrical shock, fire, or injury.</p> 
	<p>● Electrical wiring should be performed in accordance with all applicable regulations in your country. Absolutely provide a dedicated earth leakage circuit breaker and a thermal overload relay suitable for the ejector (available on the market). Imperfect wiring or improper protective equipment can lead to electrical leakage, fire, or explosion in the worst case.</p> 		<p>● Provide a secure grounding dedicated for the ejector. Never fail to provide an earth leakage circuit breaker and a thermal overload relay in your starter or control panel (Both available on the market). If an electrical leakage occurs by due to a product failure, it may cause electrical shock.</p> 

 CAUTION			
	<p>● Provide a secure ground. Do not connect the grounding wire to a gas pipe, water pipe, lighting rod, or telephone ground line. Improper grounding may lead to electrical shock.</p> 		<p>● Do not use the cabtyre cable if it is found to be damaged. Connect the cabtyre cable securely to the terminals. Failure to observe this can lead to electrical shock, short-circuit, or fire.</p> 
	<p>● Do not scratch, fold, twist, make alterations, or bundle the cable, or use it as a lifting device. The cable may be damaged, which may cause electrical leakage, short-circuit, electrical shock, or fire.</p> 		<p>● This ejector is neither dust-proof nor explosion-proof. Do not use it at a dusty place or at a place where corrosive, toxic or explosive gas presents or may be generated. Use in such places could cause fire or explosion.</p> 
	<p>● When the product will be carried by hand, decide the number of persons considering the mass of the product. When lifting up the product, do not attempt to do it by simply bowing from the waist. Use the knees, too, to protect your waist.</p>		



PRECAUTIONS DURING TEST OPERATION AND OPERATION

 WARNING			
	<p>● Never start the ejector where people are present in the aeration tank. If an electrical leakage occurs, it can cause electrical shock.</p> 		<p>● Never start the ejector while it is suspended, as the unit may jerk and lead to injury.</p> 
	<p>● When changing power connection is needed to correct the direction of rotation, be sure to turn off the power supply (earth leakage circuit breaker, etc.), and perform the work after making sure that the impeller has stopped completely. Failure to do so may lead to electrical shock, short-circuit, or injury.</p> 		<p>● When inspecting the product, be sure to turn off the power supply (earth leakage circuit breaker, etc.) so that the pump may not start accidentally. Failure to do so may lead to a serious accident.</p> 
 CAUTION			
	<p>● Do not operate the ejector under any voltage other than described on the nameplate with the voltage tolerance limit within $\pm 5\%$. If it is operated with a generator, it is strongly suggested not to operate other equipment with the same generator. Failure to observe this caution may cause malfunction and breakdown of the ejector, which may lead to electrical leakage or electrical shock.</p> 		<p>● Do not touch the product with bare hands during or after the operation, as the product may become very hot during operation. Failure to observe this caution may lead to be burned.</p> 
	<p>● Do not use the product in a liquid other than water. Use in oil, salt water or organic solvents will damage it, which may lead to electrical leakage or electrical shock.</p> 		<p>● Do not run the product dry or operate it with its valve (air-inlet valve) closed, as doing so will damage the product, which may lead to electrical leakage or electrical shock.</p> 
	<p>● Do not use the product in hot or warm liquid over 40°C, as doing so will damage the product, which may lead to electrical leakage or electrical shock.</p> 		<p>● When the ejector will not be used for an extended period, be sure to turn off the power supply (earth leakage circuit breaker, etc.). Deterioration of the insulation may lead to electrical leakage, electrical shock, or fire.</p> 
	<p>● Do not allow foreign objects (metal objects such as pins or wires) to enter the suction inlet of the ejector. Failure to observe this caution could cause it to malfunction or to operate abnormally, which may lead to electrical leakage or electrical shock.</p> 		



PRECAUTIONS DURING MAINTENANCE AND INSPECTION

 WARNING	
 <ul style="list-style-type: none"> ● Absolutely turn off the power supply before starting maintenance or inspection. Do not work with wet hands. Failure to observe these cautions may lead to electrical shock or injury. 	 <ul style="list-style-type: none"> ● Do not disassemble or repair any parts other than those designated in the operation manual. If repairs are necessary in any other than the designated parts, consult with the dealer where it was purchased or Tsurumi representative. Improper repairs can result in electrical leakage, electrical shock, or fire.
 <ul style="list-style-type: none"> ● In case any abnormality (excessive vibration, unusual noise or odor) is found in the operation, turn the power off immediately and consult with the dealer where it was purchased or Tsurumi representative. Continuing to operate the product under abnormal conditions may result in electrical shock or fire. 	
 CAUTION	
 <ul style="list-style-type: none"> ● After reassembly, always perform a test operation before resuming use of the product. Improper assembly can result in electrical leakage, electrical shock, or fire. 	

PRECAUTION TO POWER OUTAGE

 WARNING	
 <ul style="list-style-type: none"> ● In case of power outage, turn off the power supply. The ejector will resume operation when the power is restored, which presents serious danger to people in the vicinity. 	

OTHER PRECAUTION

 CAUTION	
 <ul style="list-style-type: none"> ● Never use the product for potable water. It may present a danger to human health. 	

2 NAME OF PARTS

Example

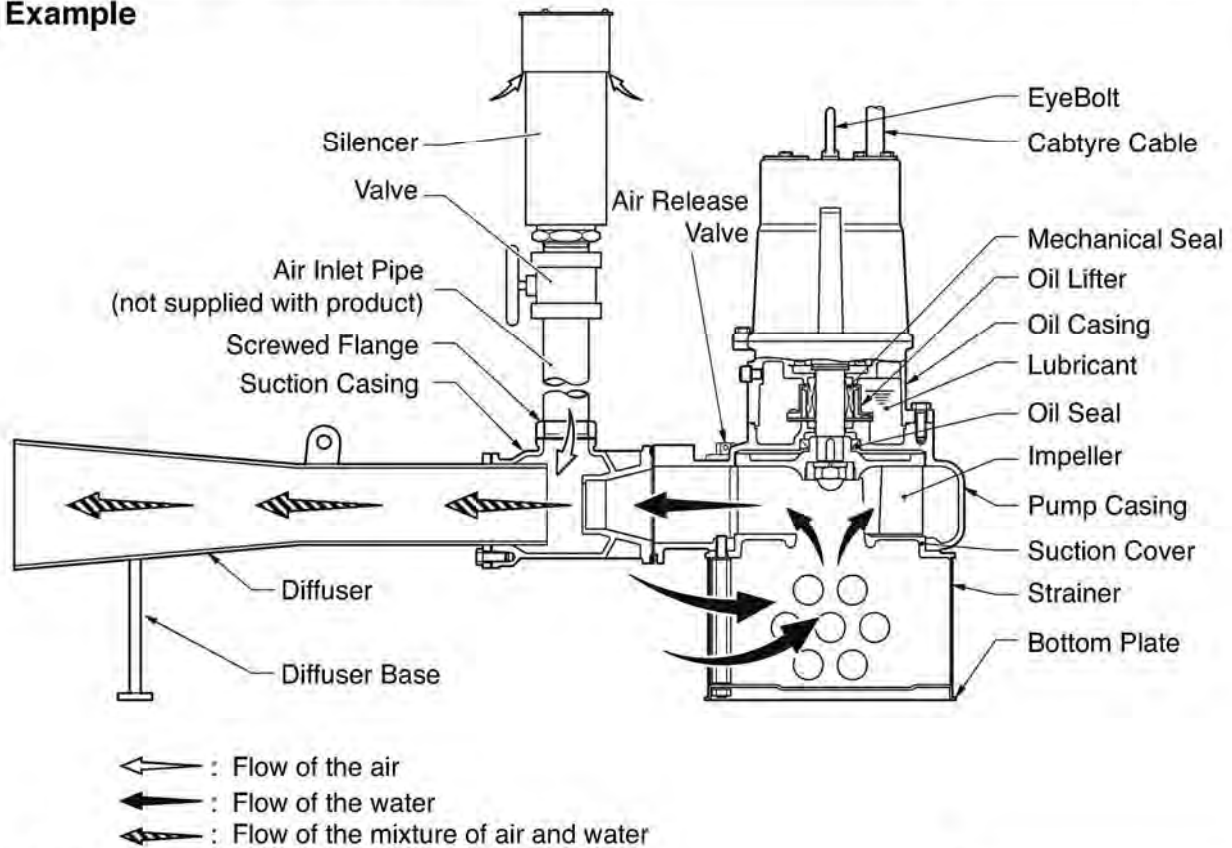

3 PRIOR TO OPERATION

When the unit is delivered, first perform the following checks.

Inspection

While unpacking, inspect the product for damage during shipment, and make sure all bolts and nuts are tightened properly.

Specification Check

Check the model number to make sure it is the product that was ordered. Be certain it is the correct voltage and frequency.

Example of nameplate

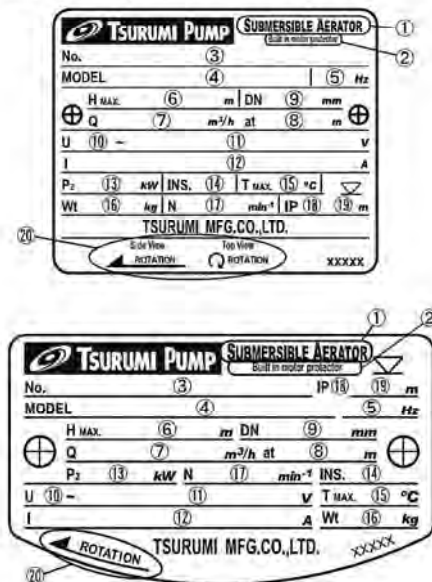

1	Submersible aerator	11	Rated voltage
2	Built in motor protector	12	Rated current
3	Serial number	13	Rated output power
4	Model	14	Insulation class
5	Frequency	15	Max. liquid temperature
6	Max. water depth (without compressor)	16	Weight without cable
		17	Speed of rotation
7	Air quantity	18	IP degree of protection
8	Operation depth	19	Max. immersion depth
9	Air inlet bore	20	Direction of rotation
10	Phase		

Accessory Check

Verify that all accessory items are included in the package.

Free Standing Specification

- Suction Casing (with bolts and packing) 1 set
- Diffuser (with bolts and packing) 1 set
- Diffuser Base (with Nuts) 1 set
- Screwed Flange (with bolts and packing) 1 set
- Silencer Valve Set 1 set
- Chain for Lifting up/down the ejector (with shackle)..... 1 set
- Operation Manual 1

Guide-Rail Specification

- Nozzle (with bolts and packing)..... 1 set
- Suction Casing 1 set
- Diffuser (with bolts and packing) 1 set
- Diffuser Base (with Nuts) 1 set
- Screwed Flange (with bolts and packing) 1 set
- Silencer Valve Set 1 set
- Guide Support (with bolts and Nuts) 1 set
- Supporter (with U-bolt) 1 set
- Guide Connector (with bolts)..... 1 set
- Chain for Lifting up/down the ejector (with shackle)..... 1 set
- Operation Manual 1

Foundation Bolts are not provided.

Note: *If there is any problem with the product as shipped, contact your nearest dealer or Tsurumi representative at once.*

Product Specifications



CAUTION

Do not operate this product under any conditions other than those for which it is specified. Failure to observe this precaution can lead to electrical shock, electrical leakage, fire, water leakage or other problems.

Fluid to be Handled

Liquid to be Handled					Gas to be Handled (Suction through Air-inlet Pipe)
Type of Liquid	Temperature [°C]	pH	Chlorine Ion Concentration [mg/l]	Electrical Conductivity [μs/cm]	
Wastewater & sewage	0 to 40	5 to 9	Below 1,000	Below 1,000	should not be inflammable, corrosive, or toxic

Major Standard Specifications

Ejector	Impeller	Channel type
	Shaft Seal	Double Mechanical Seal
	Bearing	Shielded Ball Bearing
Motor	Specifications	Dry type Submersible Induction Motor, 2-Pole (1.5kW or less), 4-Pole (2.2kW or more)
	Insulation	Class E, F
	Protection System (built-in)	Circle thermal protector
	Lubricant	Turbine oil VG32 (additive-free)

■ Standard specifications (50/60Hz)

Model	Dia. of Air Pipe (mm)	Phase	Output (kW)	Air Flow Rate at Max. Water Depth (m ³ /h)	Max. Water Depth (m)	Weight (kg)		Max. Tank Dimension		
						Free Standing	Guide-rail	Length (m)	Width (m)	Depth (m)
(TOS-) 8-BER	25	3	0.75	8/8.1	4/3.5	28	23	3	2	4/3.5
(TOS-) 8-BERS	25	1	0.75	8/8.1	4/3.5	35	30	3	2	4/3.5
(TOS-) 15-BER	32	3	1.5	24/20	4	43	34	4	3.5	4
(TOS-) 22-BER	50	3	2.2	40/32	4.5	75	61	5	5	4.5
(TOS-) 37-BER	50	3	3.7	63/56	5	91	77	6	6	5
(TOS-) 55-BER	50	3	5.5	90/75	6	149	132	7	7	6

Note: The air flow rates are expressed at the standard conditions; Temperature 20°C, 1atm.

The air flow rates may vary by up to approximately 5%.

The Maximum Water Depth is the limit of installation depth that the product can self-aspirate, and it is expressed at the standard conditions.

Mass (weight) excluding cable

4 INSTALLATION



CAUTION

- Do not use this product in liquids other than water, such as oil, salt water, or organic solvents.
- Use with a power supply voltage tolerance within $\pm 5\%$ of the rated voltage.
- Do not use in water temperatures outside the range of 0 ~ 40°C, which can lead to failure, electrical leakage or shock.
- Use only in fully assembled state.

Note: Consult your local dealer or Tsurumi representative before using with any liquids other than those indicated in this document.

■ Critical Use Pressure



CAUTION

Do not operate the ejector in an area that is exposed to a water pressure that exceeds the values given below.

Critical Use Pressure	0.3MPa(3kgf/cm ²)
-----------------------	-------------------------------

Preparation for Installation

Use a megger to measure the resistance between each core of the cabtyre cable and the (green) ground wire to verify the insulation resistance of the motor.

Insulation resistance reference value = 20M Ω minimum

Three-Phase

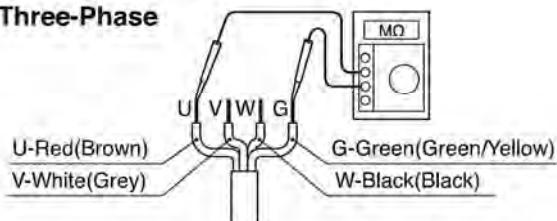

Note: The insulation resistance reference value of 20M Ω minimum is based on a new or repaired ejector.

For reference values of a ejector that has already been put into operation, refer to "7. Maintenance and Inspection" of this manual.

- (1) Install the suction casing to the pump casing. Pay attention that both flanges mate each other accurately and that all bolts are evenly tightened so that no gap is formed between the two flanges. Make sure that the screw flange seat (oval shape) faces upward. (Free-standing type only)
- (2) Install the diffuser to the suction casing. Pay attention that both flanges mate each other accurately and that all bolts are evenly tightened so that no gap is formed between the two flanges.
- (3) Fit the diffuser base temporarily to the diffuser. There is no need to tighten the nuts firmly, as the fixing height may need to be adjusted afterward. (Free-standing type only)
- (4) Loosen the nuts that have been temporarily fastened, and adjust the height of the base so that it may receive the weight of the diffuser.
- (5) Mount the screw flange on the suction casing. Refer to the "Exploded View" on Page 16 for the details such as contents, name of parts, and the shapes.

Precautions in installation

WARNING When installing the product, pay closely attention to its center of gravity and weight and keep the lifted pump horizontal by adjusting the lifting chain. Fix the diffuser and the air inlet pipe so that the pump will not fall down. If the pump is not lifted or installed correctly, it may fall or be damaged, and cause injury.

CAUTION Do not under any circumstances install or move the product by suspending it from the cabtyre cable. The cable may be damaged, causing electrical leakage, shock, or fire.

CAUTION During piping work if the welding sparks, paint, or concrete come in contact with the product, they could cause it to malfunction, which may lead to current leakage or electrical shock.

CAUTION If the product is operated while the cable or chain is drooping, they may become caught in the impeller, causing the cable to be cut or the chain to break, damaging the impeller or causing water incursion to the product, which can result in electrical leakage or shock.

CAUTION In case you have to fix the cabtyre cable, the lifting chain, slacken it a little bit and fix on the chain taking a distance of about 1 meter in between (in order to reduce burdens on the cable). Be sure to protect the cable with plastic tapes or cloth-woven hoses in this case. Due to the vibrated water flow when the ejector is operated, the cabtyre cable may touch the corners in the tank and be broken. When cabtyre cable is used under such circumstances, protect it by wrapping it with vinyl tapes or cloth-woven hoses.

- (1) Avoid bending the cabtyre cable or using it as a rope when transporting or installing the product.
- (2) Install the ejector on a horizontal and rigid surface such as concrete. (Free-standing type only)
- (3) Depending on the condition of the floor (inclined, bumpy, or slippery) or the condition of piping, the product may move or fall down after starting. Provide a proper measure if such case is predicted. A similar measure will be necessary if other equipment like a mixer is installed in the same tank as it generates water current. (Free-standing type only)
- (4) The area near the inlet is susceptible to turbulence or allows the product to take air in. Place the unit away from the inlet or install a baffle plate.
- (5) The ejector shall be placed where it can produce as even convection as possible.

Attaching a Chain to Suspend the Ejector

Refer to the illustration on the right in order to suspend the product by a chain.

CAUTION Make sure that the chain does not become twisted during installation. Failure to observe this precaution could cause the chain to break and the product to fall and break, which could lead to injury.

When you mount shackles, be also careful so that the eye-bolt (pin) may not get dislocated, by means of providing a stainless steel wire or tying band.

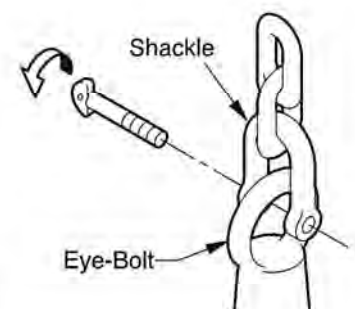

Note: To use the product with the guide rail, refer to the separate operation manual entitled "Guide Rail".

Installation Method – Free-Standing Type

- (1) Install a manhole frame and a cable conduit pipe on the floor surface above the tank, or at a location where the extension of the cable will be placed.

Note: Select the conduit pipe by referring to the diameter of the cable cable.

- (2) Connect the air inlet pipe to the suction casing and perform the piping work.

Note:

- Install the air inlet pipe as perpendicularly as possible.
- In order to minimize the operating noise, it is recommended to use a PVC pipe or a spiral-reinforced hose instead of a steel pipe.
- To minimize the friction loss in the pipe, use as few bends as possible.

- (3) Fit the silencer valve set into the air inlet pipe.

Note: The silencer shall be placed apart from the liquid surface and free from obstruction.

- (4) Check the insulation of the motor and the direction of rotation of the motor before lowering the pump into the tank.

■ Insulation resistance reference value = 20MΩ minimum

The direction of rotation is correct if the starting recoil is in the counterclockwise when observing the pump from above. For the details, refer to "Trail Operation" on page 11.

- (5) Use a hoist or a chain block to slowly lower the pump having the air inlet pipe.
- (6) Fix the diffuser base to the bottom of the tank.
- (7) Fix the air inlet pipe to the opening.
- (8) With the cable and chain lifted slightly (to avoid sagging), secure it to hooks on the manhole frame. The hooks must be prepared in advance.

Note:

- Install a hoist or a chain block for raising or lowering the pump so that it can suspend the pump at its center.
- Ensure that the cable is provided with a sufficient length. (If it is too short, it might not be possible to pull the pump above the ground surface.)

- (9) Lastly, recheck steps (1) through (8).
- (10) Thoroughly clean the inside of the tank to make sure that any concrete pieces or wires are not left behind after work.

This completes the installation work.

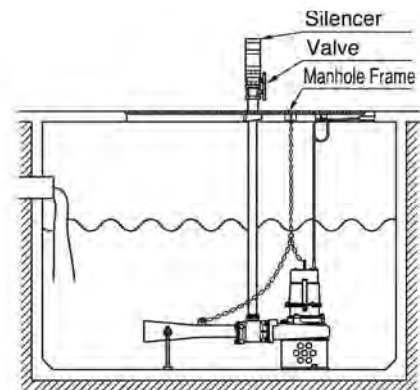
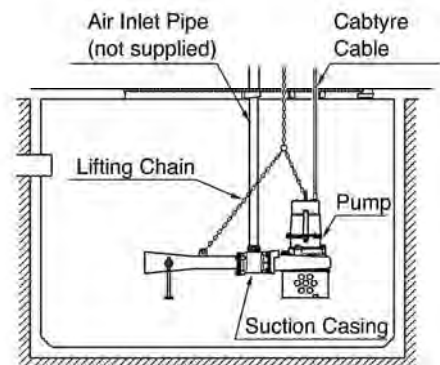
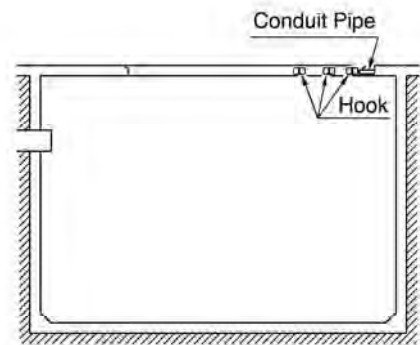

Installation Method – Guide-Rail Fitting Type

- (1) Install a manhole frame and a cable conduit pipe on the floor surface above the tank, or at a location where the extension of the cable will be placed.

Note:

- To install the guide rail perpendicularly, check the positional relationship between the manhole frame and the suction casing (Refer to the drawing in "Exploded View" on page 16), and correctly place it in accordance with the dimension drawing.
- Select the conduit pipe by referring to the diameter of the cabtyre cable.

- (2) Place the suction casing with the foundation bolts set on the bottom of the tank. Ensuring that the guide rails are installed perpendicularly, secure the guide rails by mounting the bottom end to the guide connectors and the top end to the guide support, and then secure the guide support.

Note:

- When securing the suction casing by casting foundation bolts into the concrete of the tank, follow the dimension drawing carefully.
- When other construction work is performed, cover the suction casing with a plastic sheet or the like to protect it.
- Make sure the guide pipe is vertical.
- In a deep tank where the guide pipe length is more than 4 meters, the guide pipe will have a greater tendency to warp, so that the guide hook may come free of the guide pipes when the pump is being raised or lowered. In this case an intermediate guide support (not supplied) should be used to secure the guide pipe.

- (3) Connect an air inlet pipe (the screw flange supplied with the guide rail set has been fitted.) to the suction casing.

Note:

- Install the air inlet pipe as perpendicularly as possible.
- In order to minimize the operating noise, it is recommended to use a PVC pipe or a spiral-reinforced hose instead of a steel pipe.
- To minimize the friction loss in the pipe, use as few bends as possible.

- (4) Fix the upper part of the air inlet pipe to the manhole frame (supporter).
- (5) Fit the silencer valve set into the air inlet pipe.

Note: The silencer shall be placed apart from the liquid surface and free from obstruction.

- (6) Check the insulation of the motor and the direction of rotation of the motor before lowering the pump into the tank.

■ Insulation resistance reference value = 20MΩ minimum

The direction of rotation is correct if the starting recoil is in the counterclockwise when observing the pump from above. For the details, refer to "Trail Operation" on page 11.

- (7) Use a hoist or a chain block to slowly lower the pump having the air inlet pipe. The pump will automatically connect to the suction casing.
- (8) With the cable and chain lifted slightly (to avoid sagging), secure it to hooks on the manhole frame. The hooks must be prepared in advance.

Note:

- Install a hoist or a chain block for raising or lowering the pump so that it can suspend the pump at its center.
- Ensure that the cable is provided with a sufficient length. (If it is too short, it might not be possible to pull the pump above the ground surface.)

- (9) Lastly, recheck steps (1) through (8).
- (10) Thoroughly clean the inside of the tank to make sure that any concrete pieces or wires are not left behind after work.

This completes the installation work.

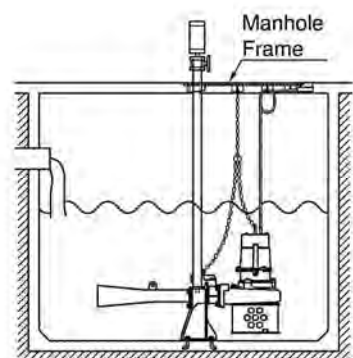
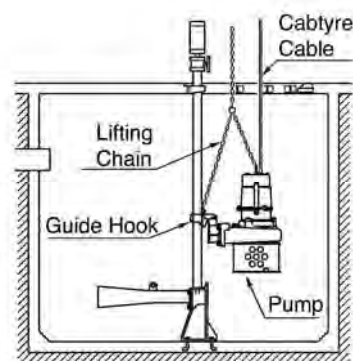
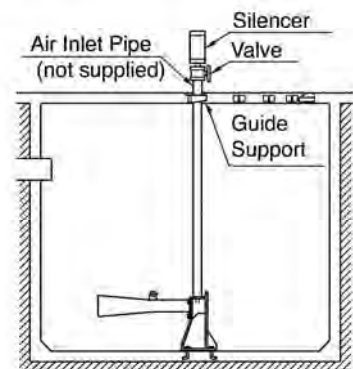
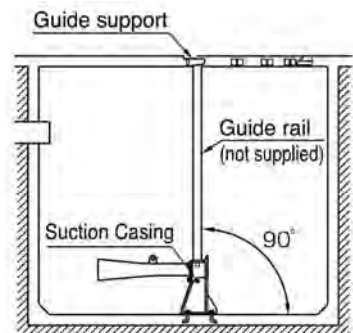
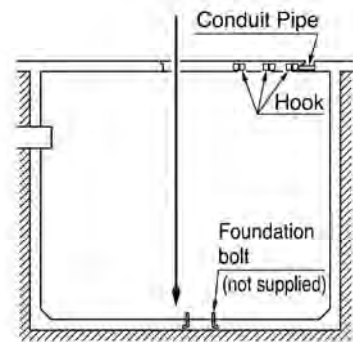

5 ELECTRICAL WIRING

Performing electrical wiring



WARNING

- Electrical wiring should be performed by a qualified person in accord with all applicable regulations. Failure to observe this precaution not only risks breaking the law but is extremely dangerous.
- Incorrect wiring can lead to electrical leakage, electrical shock or fire.
- Absolutely provide a dedicated earth leakage circuit breaker and a thermal overload relay suitable for the ejector (available on the market). Failure to follow this warning can cause electrical shock or explosion when the product fails or an electrical leakage occurs.

Operate well within the capacity of the power supply and wiring.

Grounding



WARNING

Do not use the product without first grounding it properly. Failure to ground it can lead to electrical shock from an electrical leak or malfunction.



CAUTION

Do not attach the grounding wire to a gas pipe, water pipe, lightning arrester or telephone grounding wire. Improper grounding can result in electrical shock.

Connecting the power supply



WARNING

Before connecting power supply wires to the terminals, make certain the power supply is turned off (circuit breaker, etc.), to avoid electrical shock, shorting, or unexpected starting of the product, leading to injury.



CAUTION

Do not use the product with the cabtyre cable connected loosely, which can result in electric shock, shorting, or fire.

Connect the cabtyre cable leads to the terminals as shown, being careful not to let the leads become twisted together.



Note: The cabtyre cable, if it is unused, is terminally processed. If there is a need to peel off the cable again, have the terminal processed.



CAUTION

- If it is necessary to extend the cabtyre cable, use a core size equal to or larger than the original. This is necessary not only for avoiding a performance drop, but to prevent cable overheating which can result in fire, electrical leakage or electrical shock.
- If a cable with cut insulation or other damage is submerged in the water, there is a danger of water seeping into the motor causing a short. This may result in damage to the product, electrical leakage, electrical shock, or fire.
- Be careful not to let the cabtyre cable be cut or become twisted. This may result in damage to the product, electrical leakage, electrical shock, or fire.
- If it is necessary to submerge the connection leads of the cabtyre cable in water, first seal the leads completely in a molded protective sleeve, to prevent electrical leakage, electrical shock, or fire.

Do not allow the cabtyre cable leads to become wet.

Make sure the cable does not become excessively bent or twisted, and does not rub against a structure in a way that might damage it.

Electrical Circuit Diagrams

Capacitor Start
(Output 0.75kW)
Power Supply: Single-Phase

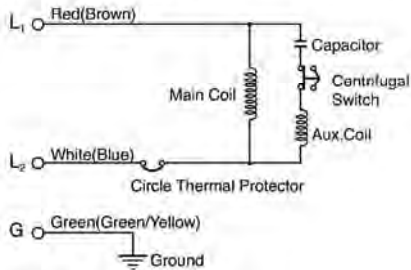

Direct-on-line
(models with 5.5kW maximum power output)
Power Supply: Three-Phase

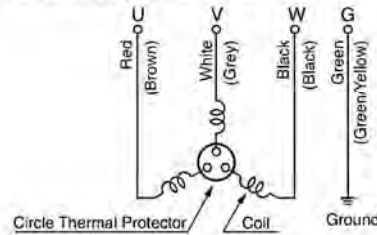

6 OPERATION

Prior to Operation

(1) Once again, check the nameplate of the ejector to verify that its voltage and frequency are correct.

CAUTION Improper voltage and frequency of the power supply will prevent the product from attaining its full potential, and may also damage the product.

Note: Verify the specs on the ejector's nameplate.

(2) Check the wiring, power supply voltage, the capacity of the ground leakage circuit breaker, and the insulation resistance of the motor.

■ Insulation resistance reference value = 20MΩ minimum

Note: The insulation resistance reference value of 20MΩ minimum is based on a new or repaired product. For reference values of a product that has already been put into operation, refer to "Maintenance and Inspection".

(3) Adjust the setting of the thermal relay (i.e. 3E relay) to the rated current.

Note: Verify the rated current on the ejector's nameplate.

Trial Operation

WARNING Never start the ejector while it is suspended, as it may jerk and cause a serious accident involving injury.

(1) Operate the ejector for a short time (1 to 2 seconds) and verify the direction of the rotation of the impeller. Observe the unit from above, and if its recoil is in the counterclockwise direction, the direction of its rotation is correct.

CAUTION Make sure to check the direction of rotation with the product exposed to the atmosphere. Operating the pump in reverse while it is submerged in water will damage the product, which may lead to current leakage and electrical shock.

(2) To reverse the rotation, the following countermeasures must be taken.

WARNING Before changing the connections for reverse rotation, make sure that the power supply (i.e. circuit breaker) is properly disconnected and that the impeller has stopped completely. Failure to observe this may lead to electrical shock, short, or injury.

COUNTERMEASURE

Interchange any two of the three wires designated U, V, and W, respectively.

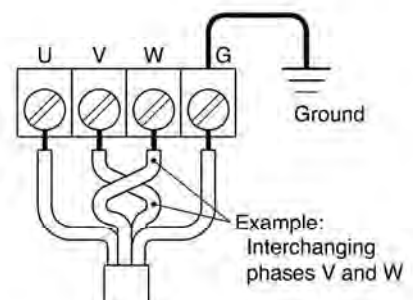

(3) Operate the product for a short time (3 to 10 minutes) and perform the following checks:

Using an AC ammeter (clamp), measure the operating current at the phases U, V, and W that are connected to the terminal board.

COUNTERMEASURE

Because an overload condition may be present at the motor if the operating current exceeds the rated current, follow the instructions in section "4. Installation" to operate the product in the correct manner.

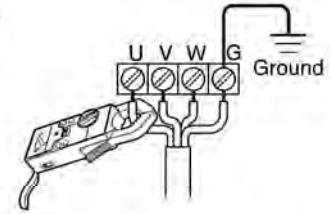

Using an AC voltmeter (tester), measure the voltage at the terminal board.

■ Power supply voltage tolerance = within $\pm 5\%$ of the rated voltage

COUNTERMEASURE

If the power supply voltage deviates from the variation value, the cause of the deviation may be the capacity of the power supply or the extension cable that is used. Refer to section "5. Electrical Wiring" to operate the product in the correct manner.

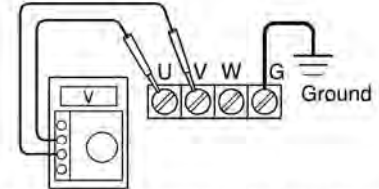

CAUTION In case it exhibits an abnormal condition (such as a considerable amount of vibration, noise, or smell), disconnect the power supply immediately and contact the dealer where you purchased the equipment, or Tsurumi's sales office in your area. If the pump continues to be used in the abnormal state, it may cause current leakage, electrical shock, or fire.

(4) Proceed with the normal operation if no abnormal conditions are found during the trial operation.

Operation

WARNING The product may be extremely hot during operation. To prevent burns, do not touch it with bare hands during or after the operation.

Pay attention to the water level during operation. The motor will become damaged if it is allowed to operate dry.

Due to an overload operation or a malfunction, if the motor protector trips to stop the motor, make sure to eliminate the cause of the problem before restarting.

A frequent ON/OFF will shorten the lifetime of the pump.

Arrange the operation mode of the product so that it will not exceed the following number of starts; less than 10 times per hour on models with the output of 0.75kW, 5 to 6 times per hour on models with the output of 1.5 to 3.7kW, and 3 to 4 times per hour on the model with 5.5kW.

Note: A large amount of amperage flows when the motor starts, causing the temperature of its windings to rise rapidly. Beware that a frequent stop-and-go operation of the product will accelerate the deterioration of the insulation of the motor windings and thus affect the use life of the motor.

Operating Water Level

CAUTION Do not operate the product below the C.W.L. (Continuous Running Water Level) indicated below. Failure to observe this condition may result in damage to the product, electrical leakage or electrical shock.

Product Model	C.W.L.	
	Free Standing Specification (mm)	Guide-rail Specification (mm)
(TOS-) 8-BER	435	485
(TOS-) 8-BERS	550	600
(TOS-) 15-BER	490	530
(TOS-) 22-BER	640	730
(TOS-) 37-BER	710	795
(TOS-) 55-BER	805	870

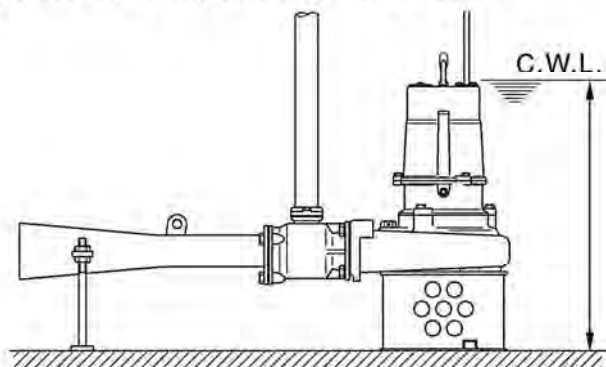

Motor Protector

The ejector is equipped with an internal motor protector.

Circle Thermal Protector:

If a current overload or overheating occurs under the symptoms given below, the product will stop automatically to protect the motor regardless of the water level at the time of operation. Because the motor protector is designed to cancel itself automatically if it trips to stop the product, remove the cabtyre cable from the terminal board and make sure to eliminate the cause of the problem, such as the following:

- Extreme fluctuation of power supply voltage
- Product operated under overload condition
- Product operated at open phase or binding condition

Note: Make sure to eliminate the cause of the problem if the motor protector has tripped. Do not operate the pump at unusually low head, or with the impeller clogged with debris. Doing so will not only prevent the pump from attaining its full potential, but may also generate abnormal noise and vibration and damage the pump.

7 MAINTENANCE AND INSPECTION

Regular maintenance and inspections are a necessity for continued efficient functioning of the product. If any abnormal conditions are noticed, refer to the section on Troubleshooting(p.17) and take corrective measures immediately. It is recommended that a spare unit be kept ready in case of any problems.

Prior to inspection

WARNING Detach the cabtyre cable from the terminals, after making certain the power supply (circuit breaker, etc.) is turned off. Do not work with wet hands. Failure to follow these precautions may result in a serious accident from electrical shock or unexpected starting of the motor.

- (1) Washing
Remove accumulated matter from the surface of the unit and wash it with clean water. Take special care to remove any debris from the impeller and the suction cover.
- (2) Inspecting the exterior
Look for any peeling or chipped paint, and make sure the nuts and bolts are fastened securely. Any cracks in the surface should be repaired by cleaning that area, drying it and then applying a touchup coating.

Note: Touchup is not supplied. Some kinds of damage or looseness may require that the unit be disassembled for repairs. Please consult with your nearest dealer or Tsurumi representative.

Regular Inspection

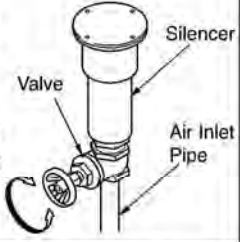
Interval	Inspection Item
EveryDay	<ul style="list-style-type: none"> ■ Measure operating current ● To be below the rated current. ■ Measure power voltage ● Power supply voltage tolerance (within ±5% of the rated voltage)
Monthly	<ul style="list-style-type: none"> ■ Measure insulation resistance ● Reference insulation resistance = 1MΩ or greater <i>Note: If the insulation resistance has become notably lower than the precious inspection, an inspection of the motor will be necessary.</i> ■ Ejector inspection ● A noticeable drop in performance may indicate wear in the impeller, suction cover, etc., or else clogging of the strainer stand, etc. Remove the clogged debris, and replace any worn parts. ■ Air inlet system check ● If performance drops significantly, check for blockage of the air inlet pipe, and for damage to the submerged part of the pipe that might cause water to leak into the pipe. Check for clogging of the silencer, and wash if necessary. 
Semi-yearly	<ul style="list-style-type: none"> ■ Inspection of lifting chain or rope ● Replace if damage, corrosion, or wear has occurred to the chain or the rope. Remove if foreign object is attaching to it.
Yearly	<ul style="list-style-type: none"> ■ Oil inspection ● Check the oil every 12 months or after 6,000 hours of use, whichever comes first. <i>Note: Refer to details of oil inspection and oil change on this page.</i>
Every 2 years	<ul style="list-style-type: none"> ■ Change oil ● Change the oil every 24 months or after 9,000 hours of use, whichever comes first. <i>Note: Refer to details of oil inspection and oil change on this page.</i> ■ Designated oil : Turbine Oil VG32 (Additive -free) ■ Change mechanical seal <i>Note: Specialized know-how is required for inspecting and replacing the mechanical seal. Consult with your nearest dealer or Tsurumi representative.</i>
Every 2 to 5 years	<ul style="list-style-type: none"> ■ Overhaul ● This should be carried out even if there are no problems with the product. The frequency depends on how continuously the product is in use. <i>Note: Consult with your nearest dealer or Tsurumi representative.</i>

Note: In case of handling liquid contains oil, paint, or slurry, it may cause the swelling of cable jacket or abrasion of the mechanical seal's sealing face, which will result in the product fault, it is strongly recommended to inspect earlier.

Storage

When the unit is out of use for an extended period, wash it and dry it thoroughly, then store it indoors.

Note: Always run a test operation before putting the unit back into service.

If the unit is left in the water, it should be run at a minimum of once a week.

Oil inspection and Oil change

Inspecting Oil

Remove the oil plug and tilt the unit to drain a small amount of oil. If the oil is milky white or has water mixed in with it, the mechanical seal may be faulty. In this case the unit will need to be disassembled and repaired.

Replacing Oil

Remove the oil plug and drain all the oil, then replace it with the specified amount of oil as shown in the table.

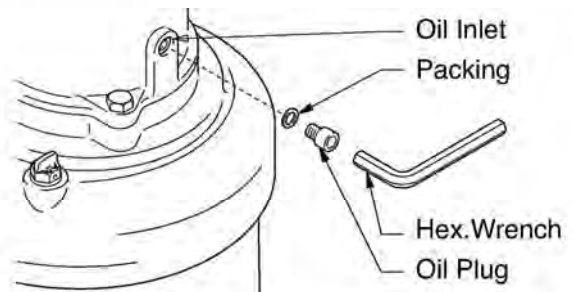

Note: Worn oil and other waste products should be disposed of by a qualified agent, in accord with applicable laws. The oil plug packing and O-ring should be replaced each time the oil is inspected or changed.

Model	Oil Quantity (ml)
(TOS-) 8-BER	440
(TOS-) 8-BERS	520
(TOS-) 15-BER	900
(TOS-) 22-BER	1,350
(TOS-) 37-BER	1,350
(TOS-) 55-BER	4,300

Replacement Parts

The table lists the parts that need to be replaced periodically. Replace these using the recommended frequency as a guideline.

Part	Recommended Frequency
Mechanical Seal	When oil becomes milky.
Oil (Turbine Oil VG 32 (Additive -free))	Every 24 months or after 9,000 hours of use, whichever comes first.
Packing, O-Ring	Each time unit is disassembled or inspected
Oil Seal	When lip is worn, and each time unit is disassembled or inspected

8 DISASSEMBLY AND REASSEMBLY

WARNING

- Before disassembling the unit, first detach the cabtyre cable from the terminals, after making certain the power supply (circuit breaker, etc.) is turned off. To avoid electrical shock, do not work with wet hands. Never check the operation of any parts (impeller rotation, etc.) by turning on the power while the unit is partially assembled. Failure to observe these precautions may result in serious accident.
- Do not disassemble or repair any parts other than those designated here. If repairs are necessary in any other than the designated parts, consult with your nearest dealer or Tsurumi representative. Improper repairs can result in electrical leakage, electrical shock, fire, or water leaks.
- After reassembly, always perform a test operation before resuming use of the product. Improper assembly will cause the product to malfunction, resulting in electrical shock or water leaks.

The procedure for disassembly and reassembly is shown here to the extent necessary for impeller replacement. A specialized know-how is necessary for work in the mechanical seal and the motor parts. Contact your nearest dealer or Tsurumi representative in the event such repairs are necessary.

Disassembly

Note: *Always remove the oil before proceeding with disassembly.*

Note: *Put a tally mark on the mating surface of each component. This will be an alignment guide in the re-assembly process. Be sure to keep the disassembled parts, paying attention not to lose any of them.*

- (1) Removing the bottom plate and strainer
Remove the hex nuts and plain washers from under the bottom plate; then, remove the bottom plate and the strainer from the suction cover.
- (2) Removing the suction cover
Remove the stud bolts, spring washers, hex bolts, and spring washers; then, remove the suction cover and the packing from the pump casing.
- (3) Removing the impeller
Using a box wrench, remove the impeller nut and spring washer; then, remove the impeller and the impeller adjusting washer from the shaft.

Exploded View

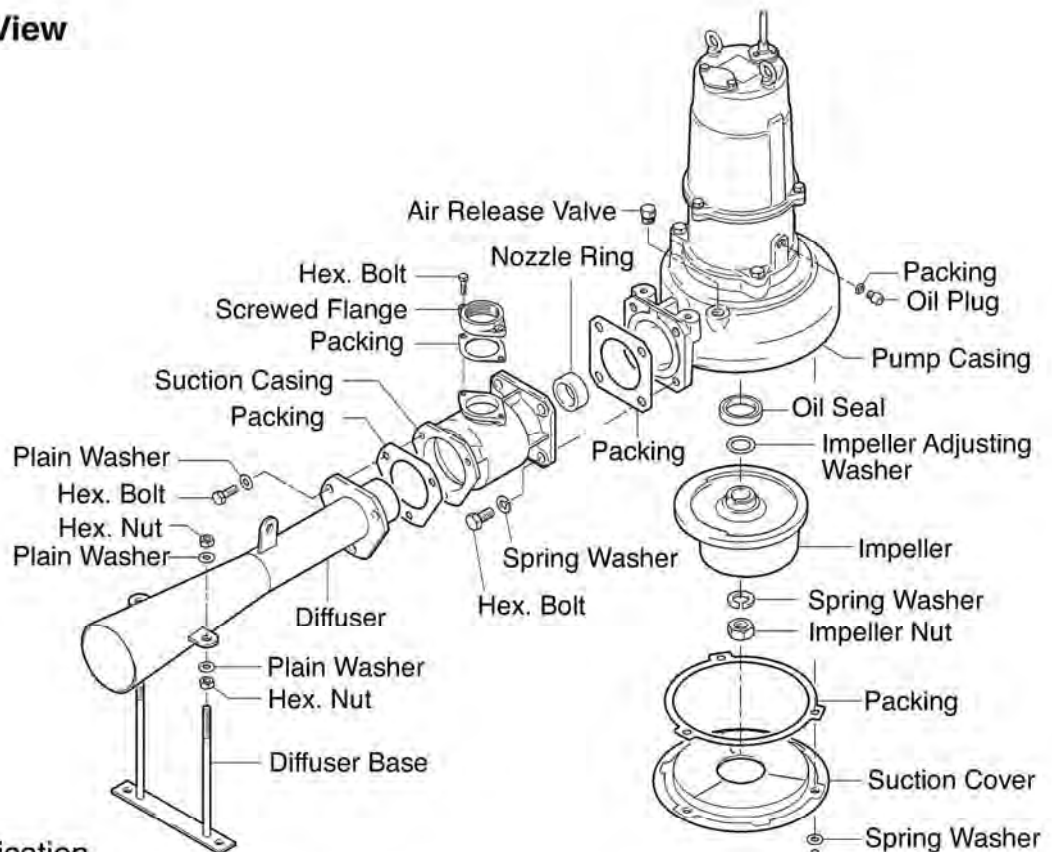

Guide-rail Specification

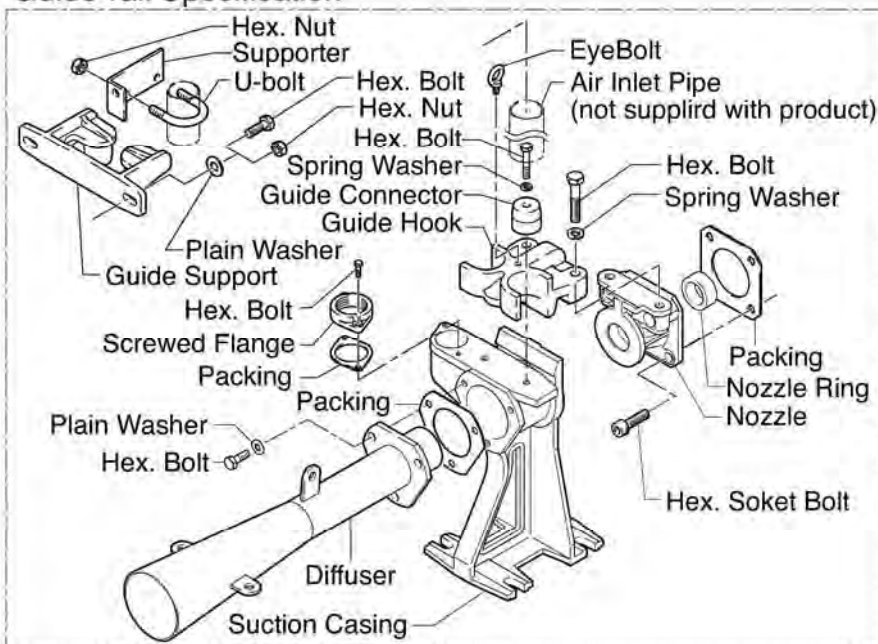

Note: The above exploded view is for model 37-BER. Other models may differ slightly in shape and construction.

Reassembly Procedure

Observe the precautions given below and reassemble the unit in the reverse order of disassembly.

Note: After completing the reassembly, make sure to fill the pump with the specified amount of oil. The packings must be replaced with a new part. If any part is worn or damaged, make sure to replace it with a new part.

After reinstalling the impeller or the suction cover, check that the impeller rotates smoothly and that there is no interference between the pump casing and the suction cover.

When reassembling, check that the assembly direction is correct and the tally marks are aligned. After reassembly, check that there is no remaining part.

9 TROUBLESHOOTING

⚠ WARNING Always turn off the power before inspecting the unit. Failure to observe this precaution can result in serious accident.

Before ordering repairs, carefully read through this operation manual, then repeat the inspection. If the problem remains, contact your nearest dealer or Tsurumi representative.

Problem	Possible cause	Countermeasure
Aerator fails to start	<ul style="list-style-type: none"> ① No power supply (power outage, etc.) ② Disconnection or inadequate connection of cabtyre cable ③ Foreign object lodging on impeller ④ Low voltage or voltage drop 	<ul style="list-style-type: none"> ① Contact the power company or an electrical repair shop. ② Check if the cabtyre cable or wiring is disconnected. ③ Check and remove any debris. ④ Provide the rated voltage, or make sure the cabtyre cable extension is the proper standard.
Stops soon after starting	<ul style="list-style-type: none"> ① Too much water depth ② Foreign object lodging on impeller ③ Impeller rubs against pump casing. ④ Impeller rubs against suction cover. ⑤ A 50Hz product is used at 60Hz. ⑥ Air inlet pipe or silencer is obstructed. ⑦ Valve is too much squeezed. ⑧ Motor error (burn, water incursion, etc.) 	<ul style="list-style-type: none"> ① Make the water depth less than specified. ② Check and remove any debris. ③ Add the impeller adjusting washer and adjust the gap between the pump casing. ④ Add the suction cover packing and adjust the gap between the impeller. ⑤ Check the nameplate, and replace the product. ⑥ Remove the obstruction or replace. ⑦ Fully open the valve. ⑧ Repair or replace the motor.
Operates but does not aerate	<ul style="list-style-type: none"> ① Air inlet pipe or silencer is obstructed. ② Valve is closed. ③ Motor rotates in reverse direction. 	<ul style="list-style-type: none"> ① Remove the obstruction or replace. ② Fully open the valve. ③ Interchange the power supply leads (p. 11).
Low performance or performance decreases	<ul style="list-style-type: none"> ① Air inlet pipe or silencer is obstructed. ② Valve is too much squeezed. ③ Impeller and/or suction cover are worn. ④ A 60Hz product is used at 50Hz. ⑤ Low voltage or voltage drop 	<ul style="list-style-type: none"> ① Remove the obstruction or replace. ② Fully open the valve. ③ Replace the worn parts. ④ Check the nameplate, and replace the product. ⑤ Provide the rated voltage, or make sure the cabtyre cable extension is the proper standard.
Not possible to raise the pump (Guide-rail fitting Type)	<ul style="list-style-type: none"> ① Mating flange of the suction casing and pump discharge flange went rusty. ② Guide hook being seized by the guide rails. ③ Cable(s) or Chain get stuck by something. 	<ul style="list-style-type: none"> ① Shake the chain mildly, and lift the unit slowly. ② Loosen the chain slightly, and lift slowly while shaking it slightly. ③ Free the point that gets stuck.

Disposal Product

Properly dispose of the product by disassembling it, presorting the contents, and sending them to the waste material treatment site.

The following information is required when ordering repairs or making other inquiries.

Product model	
Manufacturing number	
Purchase date	
Remarks	



TSURUMI MANUFACTURING CO.,LTD.

www.tsurumipump.co.jp