

KTD Series

Submersible Slurry Pumps

OPERATION MANUAL

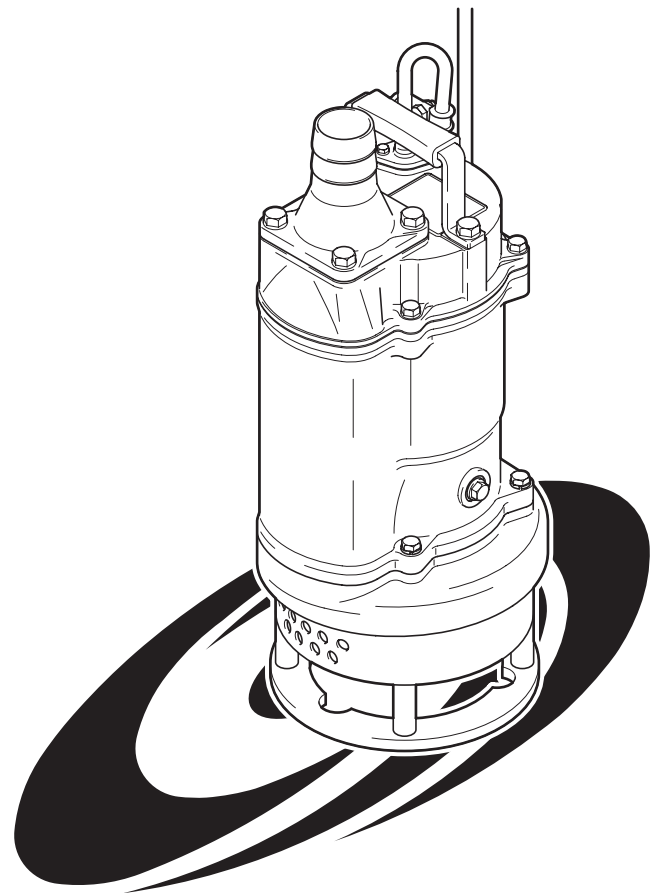

TSURUMI MANUFACTURING CO., LTD.

INTRODUCTION

Thank you for selecting the KTD Series Tsurumi Submersible Slurry Pumps.

This manual explains how to use this equipment and gives instructions on precautions to take during use.

In order to understand the features of the KTD Series and to use it in the most effective manner, read this manual before using the pump.

This equipment should not be used for applications other than those listed in this manual. In the event of a malfunction or an accident, the manufacturer will not assume any liability. We recommend that after you read this manual, you keep it on hand so that you may be able to refer to it later.

In case you lend this equipment to someone, be sure to also lend this manual together with the equipment.

In case this manual is lost or damaged, contact with the dealer from whom you purchased the equipment, or the Tsurumi sales office in your area.

This manual was prepared with the utmost attention to details. However, if you find any errors or omissions, contact with the dealer from whom you purchased the equipment, or the Tsurumi sales office in your area.

The content of this manual may not be copied, in whole or part, without consent of Tsurumi Manufacturing Co., Ltd.

CONTENTS

1. BE SURE TO READ FOR YOUR SAFETY	2
2. PUMP PART NAMES	5
3. PRIOR TO USE	5
4. INSTALLATION	7
5. ELECTRICAL WIRING	9
6. OPERATION.....	10
7. MAINTENANCE AND INSPECTION.....	13
8. DISASSEMBLY AND REASSEMBLY PROCEDURE	15
9. TROUBLESHOOTING	17

1 BE SURE TO READ FOR YOUR SAFETY

Be sure to thoroughly read and understand the SAFETY PRECAUTIONS given in this section before using the equipment in order to operate the equipment correctly.

The precautionary measures described in this section are intended to prevent danger or damage to you or to others. The contents of this manual that could possibly be performed improperly are classified into two categories: **⚠ WARNING**, and **⚠ CAUTION**. The categories indicate the extent of possible damage or the urgency of the precaution. Note however, that what is included under **⚠ CAUTION** may at times lead to a more serious problem. In either case, the categories pertain to safety-related items, and as such, must be observed carefully.

- **⚠ WARNING** : Operating the equipment improperly by failing to observe this precaution may possibly lead to death or injury to humans.
- **⚠ CAUTION** : Operating the equipment improperly by failing to observe this precaution may possibly cause injury to humans and other physical damage.
- **NOTE** : Gives information that does not fall in the WARNING or CAUTION categories.

● Explanation of Symbols:



: The \triangle mark indicates a WARNING or CAUTION item. The symbol inside the mark describes the precaution in more detail ("electrical shock", in the case of the example on the left).



: The \circ mark indicates a prohibited action. The symbol inside the mark, or a notation in the vicinity of the mark describes the precaution in more detail ("disassembly prohibited", in the case of the example on the left).



: The \bullet mark indicates an action that must be taken, or instructs how to perform a task. The symbol inside the mark describes the precaution in more detail ("provide ground work", in the case of the example on the left).













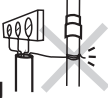





PRECAUTIONS TO THE PRODUCT SPECIFICATIONS

⚠ CAUTION	
	<ul style="list-style-type: none"> ● Do not operate the product under any conditions other than those for which it is specified. Failure to observe the precaution can lead to electrical leakage, electrical shock, fire, water overflow or other problems.



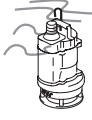

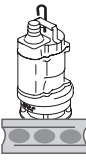







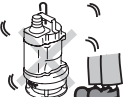

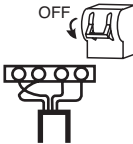



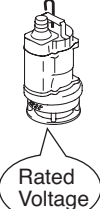



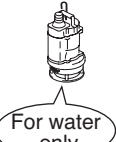

PRECAUTIONS DURING TRANSPORT AND INSTALLATION

⚠ WARNING			
	<ul style="list-style-type: none"> ● When transporting the product, pay close attention to its center of gravity and mass. Use an appropriate lifting equipment to lift the unit. Improper lifting may result in the fall of the product which could cause damage of the product or human injury. 		<ul style="list-style-type: none"> ● Install the product properly in accordance with this instruction manual. Improper installation may result in electrical leakage, electrical shock, fire, water leakage, or injury.
	<ul style="list-style-type: none"> ● Electrical wiring should be performed in accordance with all applicable regulations in your country. Absolutely provide a dedicated earth leakage circuit breaker and a thermal overload relay suitable for the product (available on the market). Imperfect wiring or improper protective equipment can lead to electrical leakage, fire, or explosion in the worst case. 		<ul style="list-style-type: none"> ● Provide a secure grounding dedicated for the product. Never fail to provide an earth leakage circuit breaker and a thermal overload relay in your starter or control panel (Both available on the market). If an electrical leakage occurs by due to a product failure, it may cause electrical shock.





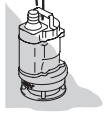

 CAUTION	
 <ul style="list-style-type: none"> ● Be sure to provide a ground wire securely. Do not connect the ground wire to a gas pipe, water pipe, lightning rod, or telephone ground wire. Improper grounding could cause electrical shock. 	 <ul style="list-style-type: none"> ● Attach a hose securely to the hose coupling. Imperfect connection of hose could cause water leakage which may result in the damage of neaby walls, floors, and other equipment. 
 <ul style="list-style-type: none"> ● Do not scratch, fold, twist, make alterations, or bundle the cable, or use it as a lifting device. The cable may be damaged, which may cause electrical leakage, short-circuit, electrical shock, or fire. 	 <ul style="list-style-type: none"> ● Do not use the cabtyre cable if it is damaged. Connect every conductor of the cabtyre cable securely to the terminals. Failure to observe this can lead to electrical shock, short-circuit, or fire. 
 <ul style="list-style-type: none"> ● When the product will be carried by hand, decide the number of persons considering the mass of the product. When lifting up the product, do not attempt to do it by simply bowing from the waist. Use the knees, too, to protect your back. 	 <ul style="list-style-type: none"> ● Use the handle when installing or carrying the pump. Never use the cable to carry or to suspend. Doing so may damage the cable which could cause electrical leakage, short circuit, or fire. 
 <ul style="list-style-type: none"> ● This pump is neither dust-proof nor explosion-proof. Do not use it at a dusty place or at a place where toxic, corrosive or explosive gas is present. Use in such places could cause fire or explosion. 	 <ul style="list-style-type: none"> ● Allow the pump to suck as few foreign object as possible. If there is a risk that the pump could be buried under the sediment, place it on a solid base like concrete block. Failure to do so may result in breakdown of the pump and could cause electrical leakage or short circuit. 
 <ul style="list-style-type: none"> ● If a hose is used for the discharge line, take a measure to prevent the hose from shaking. If the hose shakes, you may be wet or injured. 	

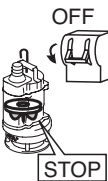

PRECAUTIONS DURING TEST OPERATION AND OPERATION

 WARNING	
 <ul style="list-style-type: none"> ● Never try to operate the pump if somebody is present in the pump sump. If an electrical leakage occurs, it can cause electrical shock. 	 <ul style="list-style-type: none"> ● When changing power connection is needed to correct the direction of rotation, be sure to turn off the power supply (earth leakage circuit breaker, etc.), and perform the work after making sure that the impeller has stopped completely. Failure to do so may lead to electrical shock, short-circuit, or injury. 
 <ul style="list-style-type: none"> ● Never start the pump while it is suspended, as the unit may jerk and could lead to injury. 	
 CAUTION	
 <ul style="list-style-type: none"> ● Do not operate the product under any voltage other than described on the nameplate with the voltage variation limit within $\pm 10\%$. If it is operated with a generator, it is strongly suggested not to operate other equipment with the same generator. Failure to observe this caution may cause malfunction and breakdown of the product, which may lead to electrical leakage or electrical shock. 	 <ul style="list-style-type: none"> ● Do not touch the product with bare hands during or immediate after the operation, as the product may become very hot during operation. Failure to observe this caution may lead to be burned. 
 <ul style="list-style-type: none"> ● Do not use the product in a liquid other than water. Use in oil, salt water or organic solvents will damage it, which may lead to electrical leakage or electrical shock. 	 <ul style="list-style-type: none"> ● Do not run the product dry or operate it with its gate valve closed, as doing so will damage the product, which may lead to electrical leakage or electrical shock. 

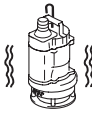

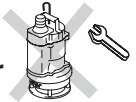
 CAUTION	
	<ul style="list-style-type: none"> Do not use the product for hot or warm liquid over 40°C, as doing so will damage the product, which may lead to electrical leakage or electrical shock. 
	<ul style="list-style-type: none"> Do not allow foreign object (pin, wire, etc.) to enter the suction inlet of the pump. Failure to observe this caution could cause it to malfunction or to operate abnormally, which may lead to electrical leakage or electrical shock. 
	
<ul style="list-style-type: none"> When the product will not be used for an extended period, be sure to turn off the power supply (earth leakage circuit breaker, etc.). Deterioration of the insulation may lead to electrical leakage, electrical shock, or fire.  	

PRECAUTIONS DURING MAINTENANCE AND INSPECTION

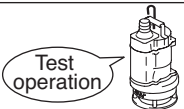

 WARNING	
	<ul style="list-style-type: none"> Absolutely turn off the power supply or disconnect the plug before starting maintenance or inspection. Do not work with wet hands. Failure to observe these cautions may lead to electrical shock or injury. 
	<ul style="list-style-type: none"> In case any abnormality (excessive vibration, unusual noise or odor) is found in the operation, turn the power off immediately and consult with the dealer where it was purchased or Tsurumi representative. Continuing to operate the product under abnormal conditions may result in electrical shock, fire, or water leakage. 
	
<ul style="list-style-type: none"> Do not disassemble or repair any parts other than those designated in the operation manual. If repairs are necessary in any other than the designated parts, consult with the dealer where it was purchased or Tsurumi representative. Improper repairs can result in electrical leakage, electrical shock, fire, or water leakage. 	

 CAUTION	
	<ul style="list-style-type: none"> After reassembly, always perform a test operation before resuming use of the product. Improper assembly can result in electrical leakage, electrical shock, fire, or water leakage. 

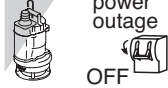
PRECAUTION TO POWER OUTAGE

 WARNING	
	<ul style="list-style-type: none"> In case of power outage, turn off the power supply. The product will resume operation when the power is restored, which presents serious danger to people in the vicinity. 

OTHER PRECAUTION

 CAUTION	
	<ul style="list-style-type: none"> Never use the product for potable water. It may present a danger to human health. 

2 PUMP PART NAMES

■ Example ; KTD22.0

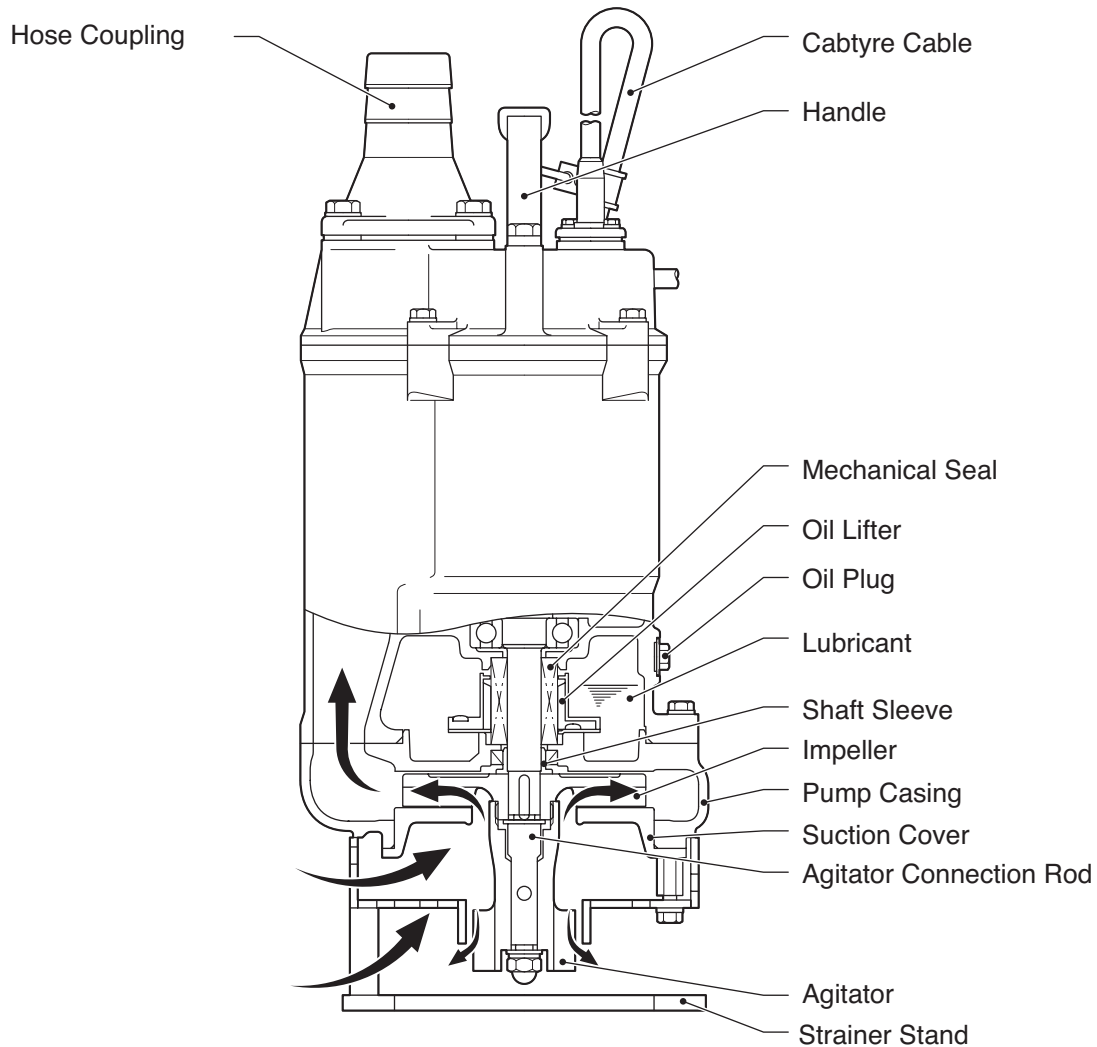

3 PRIOR TO USE

Check the following points after receiving the pump:

■ Inspecting the Product

Unpack the package and verify that no damage has occurred during shipment and that the bolts and nuts have not loosened.

■ Inspecting the Specification

Check the nameplate of the pump unit to verify that it is the product that you have ordered. Pay particular attention to its voltage and frequency specifications.

Example of nameplate

1	Submersible pump	11	Rated voltage
2	Built in motor protector	12	Rated current
3	Serial number	13	Rated output power
4	Model	14	Insulation class
5	Frequency	15	Max. liquid temperature
6	Max. total head	16	Weight without cable
7	Min. total head	17	Speed of rotation
8	Max. flow rate	18	IP degree of protection
9	Discharge bore	19	Max. immersion depth
10	Phase	20	Direction of rotation

Note: If you discover any damage or discrepancy, please contact with the Tsurumi dealer from whom you purchased the product or the nearest Tsurumi representative office.

Inspecting the Accessories

Verify that all accessory items, are include in the package.

Operation Manual..... 1

Note: If you discover any damage or discrepancy in the product, please contact the dealer where this equipment was purchased or the Tsurumi sales office in your area.

Product Specifications



CAUTION

Do not use the product under conditions other than those specified. Doing so may lead to short, electrical shock, or fire, or might inhibit the product from attaining its full potential.

Main Components Specifications

Fluid	Property	Mud and Sand carrying Water, Slurry / 0 to 40°C
Pump	Impeller	Semi-open
	Shaft Seal	Double mechanical seal
	Bearing	Shielded ball bearing
Motor	Type , Poles	Dry type submersible induction motor, 2 poles
	Insulation	Class F
	Motor Protector (built-in)	Circle thermal protector
	Lubricant	Turbine oil VG 32 (non-additive)
Discharge Connection		Hose coupling

Specifications 50/60Hz

Discharge Bore (mm)	Model	Motor Output (kW)	Max.Head (m)	Max.Capacity m ³ /min	Starting Method	Dry Weight (kg)
50	KTD22.0	2.0	19.9	0.496 / 0.419	Direct-on-Line	38
80	KTD33.0	3.0	22 / 23	0.794 / 0.789	Direct-on-Line	65

Note: The weight (mass) given above is the operating weight of the pump itself, not including the cabutyre cable.

4 INSTALLATION

⚠ CAUTION

- The supply voltage variation within $\pm 10\%$ of the rated voltage.
- To use the pump, the water temperature should be between 0°C and 40°C.
- The pump should be used only for pumping water. The pump should not be used to pump fluids such as oil, salt water, or organic solvents.
- The pump must never be used to pump explosive liquids and should never be operated in an area from whom explosive elements might be present.
- The pump must not be used in a partially disassembled state.

Note: *When using the pump for a special solution, please consult the dealer from whom you purchased the equipment, or the Tsurumi sales office in your area.*

■ Critical Pressure

⚠ CAUTION

Do not use the pump in an area where the water pressure exceeds the values given below, as it may damage the pump, or cause a short or electrical shock.

Model	Critical Pressure
KTD22.0 , KTD33.0	0.5MPa (5kgf/cm ²) — discharge pressure during use

■ Preparation for Installation

Listed below are tools and instruments that are needed to install the submersible pump for general dewatering purpose.

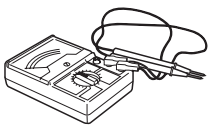

AC voltmeter
(tester)

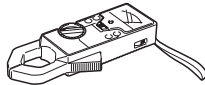

AC ammeter
(clamp)

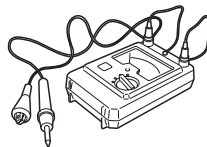

Insulation resistance
tester
(megger tester)

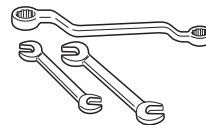

Wrenches for
fastening
bolts and nuts

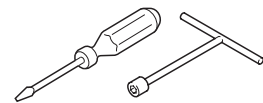

Wrenches for connecting
the power supply
(a screwdriver or a box wrench)

Note: *Consult the operation manual provided with each tester for the proper use of the tester.*

■ Pre-Installation Check

Using a megger tester, measure the resistance between each of the core wires and the ground wire (green) to verify the insulation resistance of the motor.

■ Insulation resistance reference value = 20M Ω min.

Note: *The insulation reference value of 20M Ω min. is based on a new or repaired pump. For reference values of a pump that has already been installed, refer to "7. Maintenance and Inspection" on page 13 of this manual.*

■ Precautions During Installation

- (1) Push the hose all the way to the base of the hose coupling.
Tighten the hose clamp to secure the hose in place.

Note: *A hose coupling designed for use with a suction hose is available separately. The hose coupling should be used when using a suction hose as the delivery hose.*

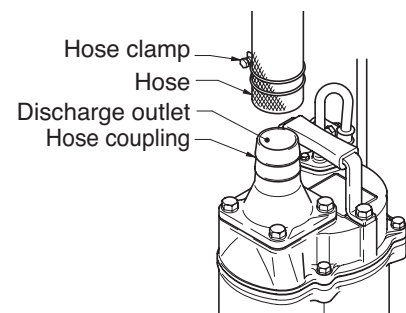

WARNING When installing the pump, be mindful of the pump's center of gravity and weight. If the pump is not suspended properly, the pump may fall and break, which may lead to injury.

CAUTION

- When installing or moving the pump, do not suspend the pump by the cable. Doing so will damage the cable, which may cause a short, electrical shock, or fire.
- When transporting the pump manually, be sure to have a sufficient number of people to carry out the task. To prevent back injury when lifting, bend your knees without bending your back.

(2) Handle the pump carefully. Do not drop it or expose it to strong impacts. When suspending the pump to raise or to lower it, attach a wire rope or a chain to the pump's handle.

Note: For proper procedures for handling the cable, refer to "5. Electrical Wiring" on page 9 of this manual.

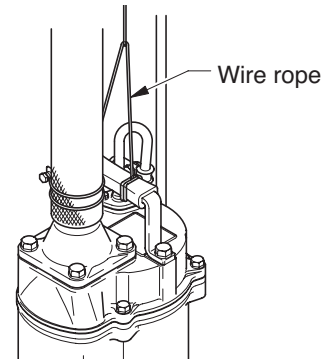

CAUTION

- Do not operate the pump dry. Doing so will prevent the pump from attaining its full potential and may also damage the pump and lead to a short and electrical shock.
- In order to properly discharge water, provide adequate piping to the area where the pump is mounted. Improper piping may lead to water leakage or other malfunctions.

(3) Install the pump only in an area that can maintain a proper water level.

Note: For details on the water level necessary for pump operation, refer to the section on "Water Level During Operation" on page 12 of this manual.

(4) When using a hose to provide piping to the pump, observe the following:
Use the shortest possible length of discharge hose and minimize the number of bends. Verify that the end of the hose (discharge side) is lifted above the water surface. If the end of the hose is submerged in water, it may cause the water to flow back when the pump has been stopped. If the end of the hose is located at a level that is lower than that of the source water surface, water may continue to flow out even after the pump has been stopped.

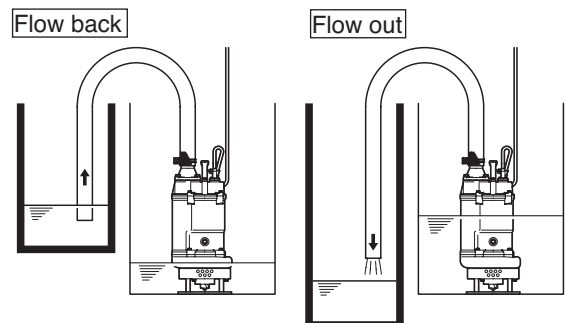

Note: Appropriate piping materials must be provided by the user. Piping materials are not included with the product.

CAUTION If an excessive amount of sediment is drawn into the pump, it may cause the pump to wear, which can lead to current leakage or electrical shock.

(5) The pump must be placed upright during operation. If there is a risk that the pump could be buried under the sediment, place the pump on a base made up of materials such as concrete blocks.

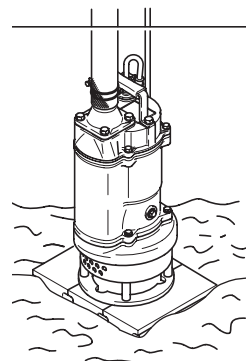

5 ELECTRICAL WIRING

Electrical Wiring Work



WARNING

- All electrical work must be performed by an authorized electrician, in compliance with local electrical equipment standards and internal wiring codes. Never allow an unauthorized person to perform electrical work because it is not only against the law, but it can also be extremely dangerous.
- Improper wiring can lead to current leakage, electrical shock, or fire.
- Absolutely provide a dedicated earth leakage circuit breaker and a thermal overload relay suitable for the pump (available on the market). Failure to follow this warning can cause electrical shock or explosion when the product fails or an electrical leakage occurs.

Be sure that the power supply and wiring have adequate capacity.

Grounding



WARNING

To prevent damaging the pump and causing current leakage, which may lead to electrical shock, be sure to install the ground wire securely.



CAUTION

To prevent electrical shock caused by improper grounding, do not connect the ground wire to a gas pipe, water pipe, lightning rod, or telephone ground wire.

Cabtyre Cable



CAUTION

- If the cabtyre cable must be extended, use an extension cable with the same or larger core size as that of the cable that is provided with the pump. Using a cable of proper size will prevent the motor from attaining its full potential or may cause the cable to overheat, which may lead to fire, current leakage, or electrical shock.
- If a cabtyre cable with a cut or damaged sheath is submerged in water, the water may enter the pump and cause the motor to short. This will damage the pump, which may lead to current leakage, electrical shock, or burn-out.
- To prevent the cable from cuts or twists, which will damage the pump and may lead to current leakage, electrical shock, or fire, be sure that the tires of vehicles do not run over the cabtyre cable.
- If the cabtyre cable must be submerged in water, be sure to mold the connection portion completely. Failure to do so may lead to current leakage, electrical shock, or burn-out.



Never submerge the ends of a cabtyre cable in water.

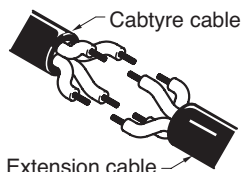

If the cabtyre cable must be extended, use an extension cable with the same or larger core size as that of the cable that is provided with the pump.



To prevent water from entering inside the cable, be sure to securely mold the cable connection portion.



To avoid damaging the cable, arrange the cable run so that the cable is not bent, kinked, or pressed against a structure.

Connecting the Cabtyre Cable

WARNING Before connecting the cabtyre cable to the terminal board, make sure that the power supply (i.e. circuit breaker) is properly disconnected. Failure to do so may lead to electrical shock, short, or injury caused by the unintended starting of the pump.

- (1) Tighten the ends of the cabtyre cable securely against the terminal board.
- (2) The figure on the right shows how to connect the cabtyre cable properly.

Direct-on-line starting

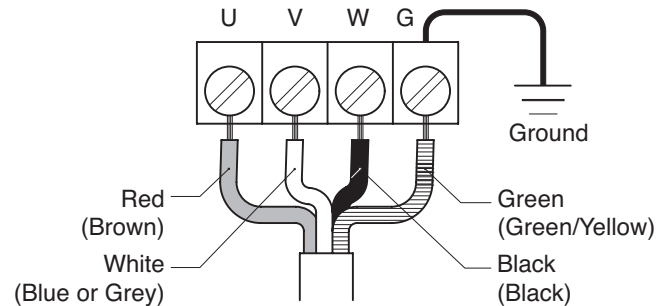

Wiring Diagram

Direct-on-line starting

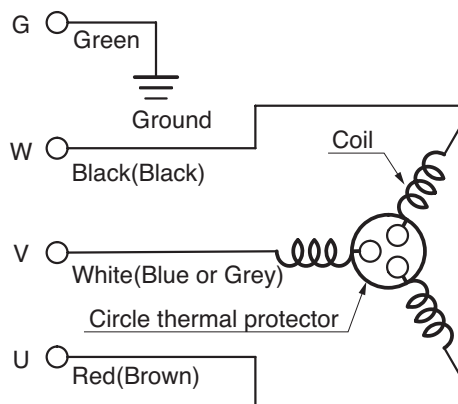

6 OPERATION

Before Operation

CAUTION Improper voltage and frequency of the power supply will prevent the pump from attaining its full potential, and may also lead to current leakage, electrical shock, or fire.

- (1) Once again, check the nameplate of the pump to verify that its voltage and frequency are correct.
- (2) Check the wiring, power supply voltage, the capacity of the ground leakage circuit breaker, and the insulation resistance of the motor.

■ Insulation resistance reference value = 20MΩ min.

Note: *The insulation reference value of 20MΩ min. is based on a new or repaired pump. For reference values for a pump that has already been installed, refer to "7.Maintenance and Inspection" on page 13 of this manual.*

- (3) Adjust the setting of the overflow protector (i.e. circuit breaker) to the pump's rated current.

Note: *Verify the rated current on the pump's nameplate.*

- (4) When using a generator, as much as possible avoid operating the pump in conjunction with other types of equipment.

▶ Trial Operation



WARNING

- Never start the pump while it is suspended, as the pump may jerk and cause a serious accident involving injury.
- Never start the pump where people are present, as they may suffer electrical shock from current leakage.



CAUTION

Be sure to check the pump's direction of rotation when the pump is exposed to atmosphere. Operating the pump in reverse while it is submerged in water will damage the pump, which may lead to current leakage, electrical shock, or fire.

- (1) Operate the pump for a short time (1 to 2 seconds), and then use a phase rotation indicator to check the rotational direction of the impeller.

Note: When using a phase rotation indicator, read the operation manual that is provided with it.



WARNING

Before changing the connections for reverse rotation, make sure that the power supply (i.e. circuit breaker) is properly disconnected and that the impeller has stopped completely. Failure to observe this may lead to serious accidents, including electrical shock, short, or injury.

■ To reverse the rotation, the following countermeasure must be taken.

COUNTERMEASURE

Interchange two of the three wires designated U, V, and W, respectively.

Direct-on-line starting

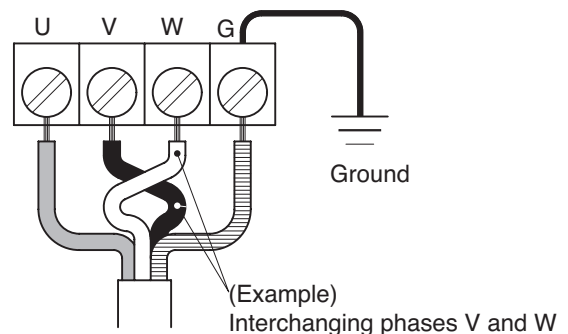

- (2) Operate the pump for a short time (3 to 10 minutes) and perform the following checks:

■ Operating current

Using an AC ammeter (clamp), measure the current at the phases U, V, and W that are connected to the terminal board.

COUNTERMEASURE

Because an overload condition may be present at the motor if the operating current exceeds the rated current, refer to the section "4. Installation" on page 7 of this manual for procedures on reverting the motor to the correct state.

■ Operating voltage

Use an AC voltmeter (tester) to measure the voltage at the terminal board.

- Power supply voltage variation = within $\pm 10\%$ of the rated voltage

COUNTERMEASURE

If the power supply voltage deviates from the variation value, the deviation may be caused by the capacity of the power supply or the extension cable that is used. Refer to the section "5. Electrical Wiring" on page 9 of this manual to provide correct voltage.

■ Vibration



CAUTION

If the pump generates a considerable amount of vibration, noise, or smell, disconnect the power supply immediately and contact the dealer where you purchased the equipment, or the Tsurumi sales office in your area.

Continue operation if no abnormal conditions are found during the trial operation.

Operation



CAUTION

- The pump may be extremely hot during operation. To prevent burns, do not touch the pump with bare hands.
- Do not insert your finger or a stick into the pump's inlet opening. Doing so may cause injury, electrical shock, short, or fire.
- When the pump is not used for a long time, make sure that the power supply (such as a breaker) is properly disconnected. If the wiring insulation deteriorates with the power supply connected, it may cause current leakage, electrical shock, or fire.

Pay attention to the water level during the pump operation. The pump will become damaged if it is allowed to operate dry.

Note: Refer to the section "Water Level During Operation" on page 12 of this manual.

The pump is equipped with an internal motor protective device (circle thermal protector).

Circle Thermal Protector



WARNING

- During inspection and repair, disconnect the power supply to avoid starting the pump unintentionally. Failure to disconnect the power supply may lead to serious accidents including electrical shock, short, and injury.
- During a power outage, disconnect the power supply to the pump. Unintentional operation of the pump after power resumption would be extremely dangerous to people around the pump.



CAUTION

- Unless the cause of a problem is removed, the pump will repeat the stop-and-go cycle, eventually resulting in damage to the pump, and causing current leakage and electrical shock. Therefore, after verifying that the power supply is disconnected, find and correct the cause of the problem through inspection and repair.
- Do not operate the pump at unusually low head, or when the strainer is clogged with debris. Doing so will prevent the pump from attaining its full potential, and may also generate abnormal noise and vibration and cause damage to the pump, which may lead to current leakage, electrical shock, and fire.

To protect the motor, if a current overload occurs in the motor or if the motor overheats under the conditions given below, the pump will stop automatically, regardless of the water level during operation.

- Extreme fluctuation of power supply voltage
- Pump operated under overload condition
- Pump operated at open phase or binding condition

Water Level During Operation



CAUTION

Do not operate the pump below Continuous running Water Level (C.W.L.), as doing so will damage the pump, causing current leakage and electrical shock.

The table below shows the water level during operation by output. Make sure that the water level will not be under these levels.

Model	C.W.L.
KTD22.0	140mm
KTD33.0	160mm

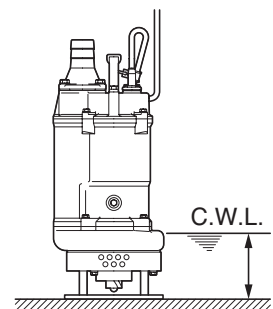

7 MAINTENANCE AND INSPECTION

Periodic maintenance and inspection are indispensable in maintaining the pump's performance. If the pump behaves differently from its normal operating condition, refer to the section "9. Troubleshooting" on page 17 of this manual and take appropriate measures at an early stage. We also recommend that you have a spare pump on hand.

Periodical Inspection

1. Before Inspection



WARNING Make sure that the power supply (i.e. circuit breaker) is disconnected, and remove the cabtyre cable from the terminal board. Failure to do so may cause electrical shock or unintended starting of the pump, which may lead to serious injurious accidents

(1) Washing the Pump

Remove any debris attached to the pump's outer surface, and wash the pump with tap water. Pay particular attention to the impeller area, and completely remove any debris from the impeller.

(2) Inspecting the Pump Exterior

Verify that the paint is not peeled, that there is no damage, and that the bolts and nuts have not loosened. If the paint has peeled, allow the pump to dry and apply touch-up paint.

Note: *Touch-up paint must be provided by the user. If the pump must be disassembled due to damage or loose bolts or nuts, contact the dealer from whom you purchased the equipment, or the Tsurumi sales office in your area.*

Regular Inspection

Interval	Inspection Item	
EveryDay	<ul style="list-style-type: none"> ■ Measure operating current ■ Measure power supply voltage 	<ul style="list-style-type: none"> ● To be below the rated current ● Power supply voltage variation (within ±10% of the rated voltage)
Monthly	<ul style="list-style-type: none"> ■ Measuring insulation resistance ■ Inspecting the impeller <p><i>Note: The motor must be inspected if the insulation resistance is considerably lower than that obtained during the last inspection.</i></p>	<ul style="list-style-type: none"> ● Insulation resistance reference value = 1MΩ min. ● If the performance level has decreased considerably, the impeller may be worn.
Semi-yearly	<ul style="list-style-type: none"> ■ Inspection of lifting chain or rope ■ Inspecting oil 	<ul style="list-style-type: none"> ● Replace if damage, corrosion, or wear has occurred to the chain or the rope. Remove if foreign object is attaching to it. ● Check the oil every 6 months or after 2,000 hours of use, whichever comes first. <p><i>Note: Refer to the section "Oil Inspection and Change Procedures" on page 14 of this manual.</i></p>
Yearly	<ul style="list-style-type: none"> ■ Change oil ■ Change mechanical seal 	<ul style="list-style-type: none"> ● Change the oil every 12 months or after 4,000 hours of use, whichever comes first. <p><i>Note: Refer to details of oil inspection and oil change (p.14)</i></p> <p><i>Note: Contact the dealer from whom you purchased the equipment, or the Tsurumi sales office in your area to inspect and replace the mechanical seal.</i></p>
Every 2 to 5 years	<ul style="list-style-type: none"> ■ Overhaul 	<ul style="list-style-type: none"> ● The pump must be overhauled even if the pump appears normal during operation. The pump may need to be overhauled earlier if it is used continuously or repeatedly. <p><i>Note: Contact the dealer from whom you purchased the equipment, or the Tsurumi sales office in your area to overhaul the pump.</i></p>

Storage

If the pump will not be operated for a long period of time, pull the pump up, allow it to dry, and store it indoors.

Note: *Be sure to perform a trial operation before reinstalling the pump.*

If the pump remains immersed in water, operate the pump on a regular basis (i.e. once a week) to prevent the impeller from seizing due to rust.

Oil Inspection and Changing Procedures

Inspecting Oil

Remove the oil plug and take out a small amount of oil. The oil can be extracted easily by tilting the pump so that the oil plug faces downward. If the oil appears discolored or intermixed with water, a likely cause is a defective shaft sealing device (i.e. mechanical seal), which requires that the pump be disassembled and repaired.

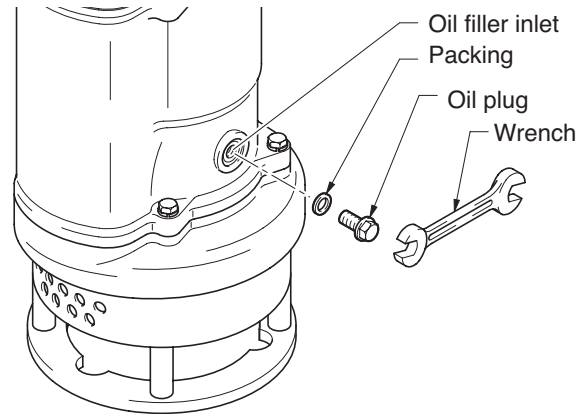

Changing Oil

Remove the oil plug and drain the oil completely.
Pour a specified volume of oil into the oil filler inlet.

Note:

- *The drained oil must be disposed of by waste disposal contractors in compliance with the laws of the locale where the pump is being used.*
- *The Packing and the O-ring for the oil filler plug must be replaced with a new part at each oil inspection and change.*

Model	Oil Quantity (ml)
KTD22.0	740
KTD33.0	1,250

Replacement Parts

The parts listed below are dispensable items. As a rule of thumb, use the replacement period as a guide to replacing these parts.

Part	Replacement condition
Mechanical seal	When oil in oil compartment becomes milky.
Lubricant : Turbine oil VG32 (non-additive)	Every 4,000 hours of 12 months, whichever comes first.
Packing and O-ring	Each time pump is disassembled or inspected
Oil seal	When the lip is worn, and each time pump is disassembled or inspected
Shaft sleeve (2.0kW)	When it becomes worn.

■ Prior to Disassembly and Reassembly**WARNING**

Before disassembling and reassembling the pump, be sure that the power supply (i.e. circuit breaker) is disconnected, and remove the cable from the outlet or the terminal board. Do not connect or disconnect the power plug with a wet hand, in order to prevent electrical shock. Do not perform an activation test (to check the rotation of the impeller) during disassembly and reassembly. Failure to observe this precaution could lead to a serious accident, including injury.

This section explains the disassembly and reassembly processes that are involved up to the replacement of the impeller itself. Operations involving the disassembly and reassembly of the sealing portion (i.e. mechanical seal) and of the motor require a specialized facility including vacuum and electrical test equipment. For these operations, contact the dealer where this equipment was purchased, or the Tsurumi sales office in your area.

Disassembly Procedure for KTD22.0

Note: *Before disassembling, be sure to drain the oil from the pump.*

- (1) Removing the strainer stand
Remove the hexagonal nut and the spring washer from the bottom and remove the strainer stand from the pump.
- (2) Removing the suction cover
Remove the stud bolt, plain washer, and remove the suction cover, suction cover packing from the pump.
- (3) Removing the agitator and impeller
With a box wrench or the like, remove the impeller nut, spring washer and plain washer, remove the agitator from its connection rod and plain washer, then remove the impeller, impeller adjusting washer and shaft sleeve from the shaft.

**CAUTION**

When removing the agitator, do not strike it with a hammer or the like, which can damage it.

Disassembly Procedure

KTD22.0

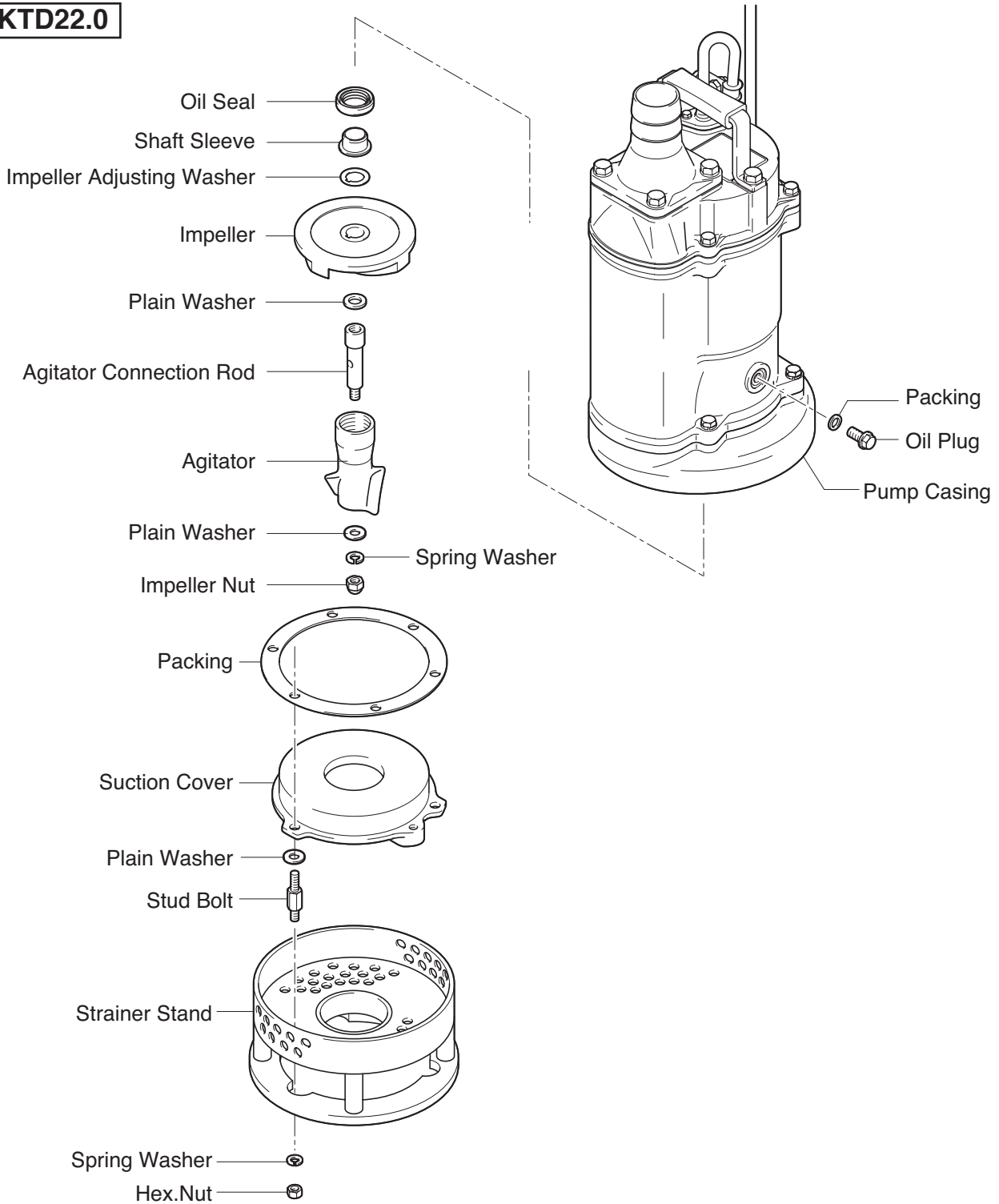

Note: *The above exploded view is for model KTD22.0. KTD33.0 may differ slightly in shape and construction.*

Reassembly Procedure

The reassembly procedure is the reverse sequence of disassembly.

Note:

- After completing reassembly, do not forget to pour the specified amount of oil into the pump.
- The packings and O-rings must be replaced with new parts. Also replace any parts that are worn or damaged.

After attaching the impeller, and again after completing assembly, check to make sure the impeller rotates smoothly.

9 TROUBLESHOOTING

⚠ WARNING To prevent serious accidents, disconnect the power supply before inspecting the pump.

Read this Operation Manual carefully before requesting repair. After re-inspecting the pump, if it does not operate normally, contact the dealer from whom you purchased the equipment, or the Tsurumi sales office in your area.

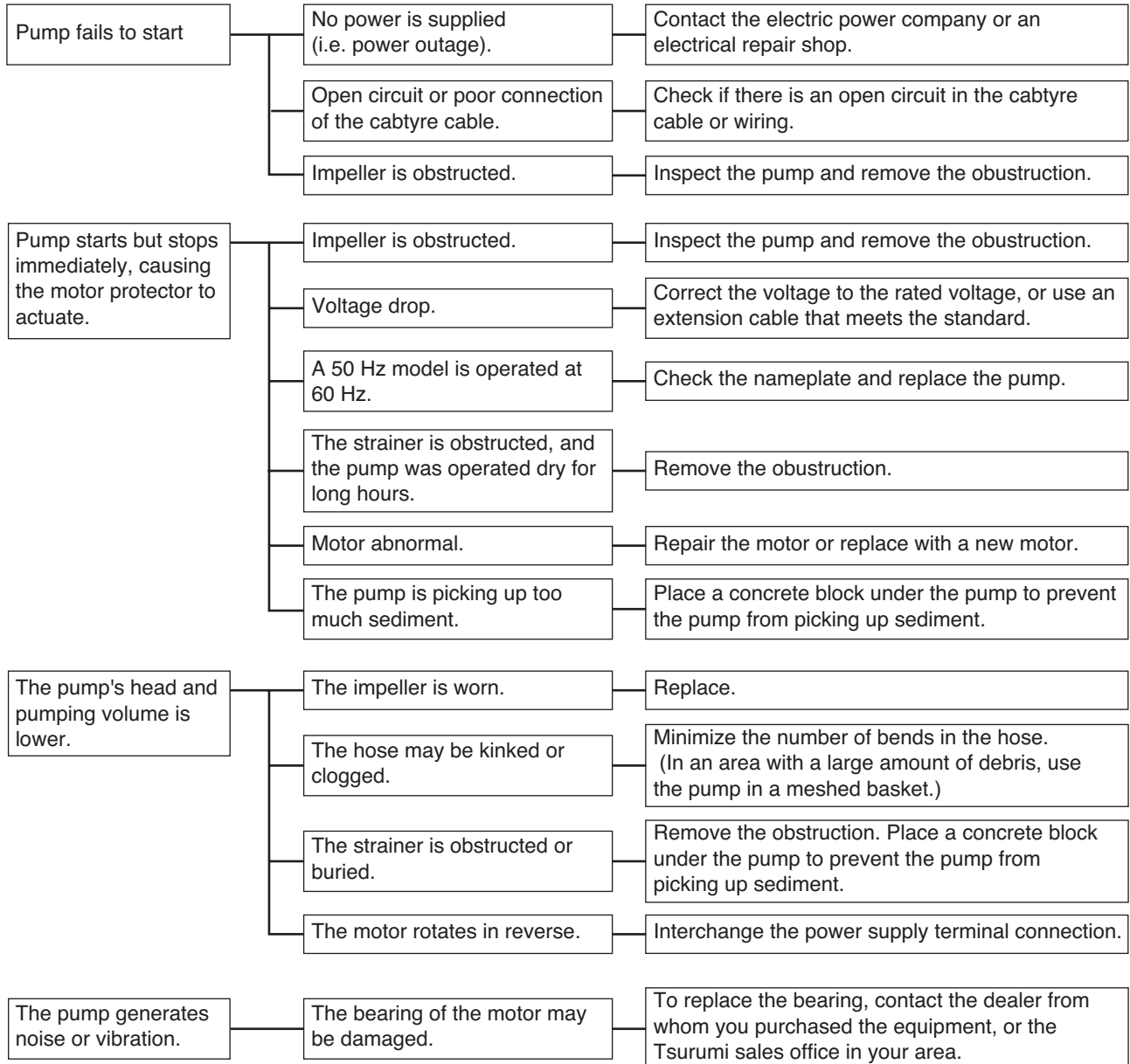

The information listed below is needed for repair or for contacting Tsurumi.

Product model	
Manufacturing number	
Purchase date	
Remarks	

Disposal of Product

Properly dispose of the product by disassembling it, presorting the contents, and sending them to the waste material treatment site.